

Contents

How to Order SmartDraw

[How to Order SmartDraw](#)

Getting Started

[Welcome to SmartDraw!](#)

[What's New In SmartDraw 4](#)

[SmartDraw 4 Professional Features](#)

[Installing SmartDraw](#)

[Installing SmartDraw on a Network](#)

[Running SmartDraw](#)

[Getting Help](#)

[Creating a New Drawing](#)

[Selecting a Template](#)

[Closing and Saving Drawings](#)

[Opening an Existing Drawing](#)

[Drawings and Windows](#)

[Right Mouse Button Menus](#)

[The Program Toolbar](#)

[The Document Toolbar](#)

[Rulers and Grids](#)

[Symbol Library Windows](#)

[Undo](#)

[Changing the Page Size and Orientation](#)

[Page Margins](#)

[Storing Two or More Drawings in the Same Document](#)

[Default Settings](#)

[Exiting SmartDraw](#)

[The Basics of Flow Charting](#)

The SmartDraw Quick Tutorial

[SmartDraw Quick Tutorial: The Basics of SmartDraw in 12 Easy Lessons](#)

[Tutorial Lesson 1: Starting the Program](#)

[Tutorial Lesson 2: Basic Drawing](#)

[Tutorial Lesson 3: Selecting Objects](#)

[Tutorial Lesson 4: Using Lines](#)

[Tutorial Lesson 5: Adding Text to Your Drawings](#)

[Tutorial Lesson 6: Colors, Shading, Borders, Arrowheads](#)

[Tutorial Lesson 7: Automatic Connectors \(the Easy Way to Draw Perfect Charts\)](#)

[Tutorial Lesson 8: How to Line Things Up](#)

[Tutorial Lesson 9: Grouping and Un-Grouping Objects](#)

[Tutorial Lesson 10: Using the Libraries](#)

[Tutorial Lesson 11: Tables and Forms](#)

[Tutorial Lesson 12: The Professional Finish \(Colors and Shadows\)](#)

Drawing with SmartDraw

[Adding Objects](#)

[Sticky Tool Selection](#)

[Drawing Lines and Curves](#)

[Selecting Objects](#)

[Moving Objects](#)

[Sizing Objects](#)

[The Shape Sizing Dialog](#)

[The Position and Size Dialog](#)

[Rotating Objects](#)

[Flipping Objects](#)

[Deleting Objects](#)

[Duplicating Objects](#)

Changing the Appearance of a Drawing

[Changing the Appearance of Shapes](#)

[Changing the Shape](#)

[Adjusting Shape Outlines](#)

[Redesigning Shape Outlines](#)

[Changing the Appearance of Lines](#)

[Arrowhead Dialog](#)

[Creating Your Own Arrowheads](#)

[Changing Line Shape](#)

[Changing the Background Color](#)

[Colors and Shadows](#)

[Overriding Shadows](#)

[Defining Your Own Styles](#)

Overriding Styles

Adding Text

Entering Text in Shapes

Automatic Text Resizing

Text Entry Properties

Entering Background Text

Attaching Text to Lines

Dimensioning: Showing Line Length

Changing Fonts, Size and Style

Changing Text Using the Toolbar

Positioning Text Inside Shapes

Positioning Text Along Lines

Deleting Text

Inserting Symbols

Special Characters

Bulleted Text

Changing Text Color

Changing Text Shadows

Using Tables

What are Tables?

Adding Tables to a Drawing

Changing a Normal Shape into a Table

Changing a Table into a Normal Shape

Rows, Columns and Cells

Formatting Tables

Adding Table Formats of Your Own

Adding Text to Tables

Moving Around the Table

Selecting Cells

Applying Changes to Selected Cells

Selecting Cell Dividers

Moving Cell Dividers

Changing the Width and Height of Cells.

Spacing Rows and Columns Evenly

Resizing the Table Object

Joining and Splitting Cells.

Inserting Rows, Columns and Cells

Appending Rows and Columns

Deleting Rows, Columns and Cells

Deleting, Copying and Pasting Text

Changing the Appearance of a Table Object

AutoFill

Using Tables

Arranging Objects

Arranging Objects

Using Snaps

Aligning Objects

Making Objects the Same Size

Spacing Objects Evenly

Centering the Drawing on the Page

Changing the Front-to-Back Order

Locking Objects

Connecting Lines and Shapes

Linking Objects to Each Other

Linking a Line to a Shape

Infinite and Fixed Connection Points

Turning Linking On and Off

Linking Shapes to Each Other

Linking Lines to Each Other

Formatting with Automatic Connectors

Using Automatic Connectors

Adding Connectors to a Drawing

Changing a Connector's Shape

Adding Shapes to a Connector

Linking Automatic Connectors to Each Other

Adjusting the Connector Spacing

Changing an Automatic Connector's Appearance

Using Automatic Connectors in Flow Charts

Symbol Libraries

Libraries

Document Toolbars

Opening a Symbol Library

Searching for Symbols

Library File Organization

Changing the Settings for a Symbol

Adding New Symbols to a Library

Transferring Drawings Between Libraries

Creating a New Library

Sharing Libraries on a Network

Creating Your Own Shapes

Joining Lines to Make a New Shape

Grouping and Ungrouping

Viewing and Printing

The SmartDraw Drawing Area

Changing the View

Setting the Ruler Scale

Printing

Page Setup

Print Preview

The Print Dialog

Keyboard Navigation

Selecting with the Tab Key

The Tab Order

Text Entry and the Tab Key

SmartDraw and Forms

Using SmartDraw with Other Programs

Copying and Pasting

Image Objects

Importing Images From Other Programs

Ungrouping Imported Images

Opening Files Created with Other Flowchart Programs

Exporting Drawings

[Exporting Images to Web Pages](#)

[Hyperlinking to Files and Web Pages](#)

[Using Hyperlinks](#)

Using SmartDraw with Microsoft Office

[Transferring Drawings from SmartDraw to Office.](#)

[Inserting a SmartDraw Object into Word](#)

[Transferring Objects from Office to SmartDraw](#)

[Microsoft Office Companion](#)

[Adding Objects with Paste and Paste Special](#)

[Inserting Objects](#)

[Editing OLE Objects](#)

[Managing Links](#)

Text Tools

[Spelling Correction](#)

[The Check-Spelling Dialog](#)

[Selecting a Spelling Language](#)

[The Dictionary Dialog](#)

[Spelling Options](#)

[Find and Replace](#)

Customizing SmartDraw

[New Drawing Buttons](#)

[Creating SmartDraw Templates](#)

[Designing Templates](#)

[Skipping the New Drawing Dialog](#)

[The Options Dialog](#)

[Changing the Program Toolbar](#)

[Defining Your Own Menu Colors](#)

Appendix A Technical Support

[Technical Support](#)

[Troubleshooting](#)

SmartDraw Tips and Tricks

[How Do I?](#)

SmartDraw License Agreements

SmartDraw Software License Agreement (Purchased Copy)

SmartDraw Software License Agreement (Trial Edition)

How to Order SmartDraw

When your trial period expires, you can continue working by purchasing the full version of SmartDraw, which will replace your **Trial Edition**.

If you choose to purchase on-line, you can choose to download and use the full version immediately.

However if you choose to wait for the full version to be shipped to you on CD or diskettes, you will be given a code that will extend your trial for a limited time while you wait for the full version to be delivered. [This extension only works once!]. Whichever way you choose to receive the full version, you can resume working immediately after you order.

Any drawings you created with the **Trial Edition** will be preserved, and you can open them with the full version.

SmartDraw Standard is just **\$49**.

SmartDraw Professional is **\$99** and *includes a Spelling checker, Postscript, AutoCAD and other advanced import and export filters, PLUS two FREE clipart art collections (a \$38 value). And with Microsoft Office installed on your PC, you can add "live" Graphs, Equations, WordArt and other Microsoft Office objects to your drawings in SmartDraw Professional.*

Order On-Line

You may purchase the full, unlimited copy SmartDraw on the Internet at:

<http://www.smartdraw.com>

If you order on-line, you can choose to have physical media (CD, disks and manuals) shipped to you, *and* you can immediately download the program directly to your PC. You can choose to:

- **Download without receiving physical media**
- **Receive physical media without downloading**
- **Both download and receive physical media**

Choosing electronic delivery directly to your PC saves you time and shipping charges. Whether you download or purchase a CD, you'll get an electronic version of the SmartDraw User's Guide (the manual). You can also order a perfect-bound printed copy of the manual.

On-line ordering is by credit card only. Visit the web site for details.

By Phone

Call to order, 24 hours per day, 7 days per week:

- **1 800 501 0314** within the US and Canada, or call
- **(619) 549 0314**, outside the US

By Fax

Fax your order to:

- **(619) 549 2830** worldwide
- Your order will usually be shipped within one business day.

Order Forms

You can view and print order forms for purchasing SmartDraw from SmartDraw Software Inc., or from our international distributors, by using the **Order SmartDraw** command under the SmartDraw Help menu.

Site Licenses

Both SmartDraw Software, and its international distributors, offer multiple user licenses. The details are provided on the order forms.

Welcome to SmartDraw!

SmartDraw is the easy-to-use program that lets anyone draw great looking flowcharts, diagrams, forms and other business graphics. You don't have to be an artist to get results with SmartDraw.

SmartDraw automatically aligns shapes, lines and text. Its unique, built-in library of design styles lets you pick professional looking color schemes, shadows, and textures for your drawings with the click of a mouse. Libraries of SmartDraw *Symbols* provide an unlimited selection of clip-art that you can edit or add to.

SmartDraw works as a stand-alone program, and as part of Microsoft Office and other programs that support Object Linking and Embedding (OLE). You can insert a SmartDraw drawing directly into Microsoft Word for Windows, using the Insert Object command. With the Professional version of SmartDraw, you can also insert Office documents, like graphs, equations, and spreadsheets into your drawings as SmartDraw symbols.

SmartDraw comes in three different flavors:

SmartDraw Standard

This is the standard edition of SmartDraw. It is a 32-bit Windows application and requires a 486 (or better) PC running Microsoft Windows 95, 98, or Windows NT 4.0 or later.

SmartDraw Professional

The professional edition of SmartDraw has all the features of SmartDraw Standard plus a collection of more advanced features, including:

- Spelling checker
- Find and Replace
- Advanced import and export filters
- OLE Client Support
- The Microsoft Office Companion

It too is a 32 bit Windows application and requires a 486 (or better) PC running Microsoft Windows 95, 98, or Windows NT 4.0 or later.

SmartDraw 3 for Windows 3.1

This is a 16-bit version of SmartDraw for Windows 3.1 users. It requires a 386 (or better) PC and Windows 3.1. It has fewer features than either SmartDraw Standard or Professional.

This Manual

Professional

This manual is common to all three versions. The icon in the margin to the left indicates professional-only features. The features SmartDraw 3 lacks are described in the *What's New in SmartDraw 4* section that follows.

What's New In SmartDraw 4

For users upgrading from earlier versions of SmartDraw, we highlight here some of the new features found in SmartDraw version 4. This section is also helpful to Windows 3.1 users of SmartDraw 3, since it lists the features *not* available to them currently.

Automatic Text Resizing

SmartDraw shapes have always automatically changed size to accommodate the text entered inside them.

SmartDraw 4 tries to avoid changing the size of a shape as text is entered by first reducing the size of the text. Deleting excess text causes the text to grow back to its original size.

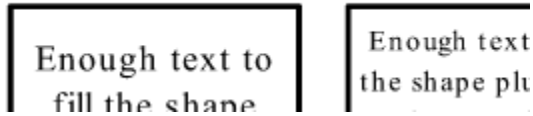

The effect of Automatic Text Sizing

Tables

SmartDraw 4 supports tables. Tables are multiple text-entry areas within a shape, arranged in rows and columns. Using SmartDraw 4's powerful table editor you can insert and manipulate tables inside any shape. A whole chapter of this manual (page 97), is dedicated to tables.

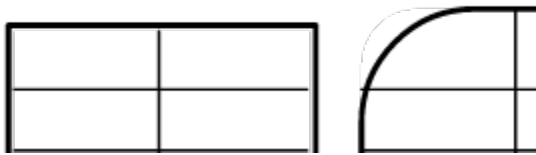

Different shapes containing the same 2x4 table.

More Colors

SmartDraw 4 gives you access to any of the more than 16 million colors supported by Windows. You can also redefine any of the 48 standard colors that show on the color menus.



New Color Menu

Absolute Positioning of Objects

SmartDraw's new Position Dialog allows users to specify the size and location of any object to within 1/100 of an inch.

Infinite Connection Points

In the past, most SmartDraw shapes had a fixed number of *Connection Points* where lines, or other shapes, could link to them. In SmartDraw 4, all shapes may have infinite connection points, so that lines can be attached to them anywhere.

User-defined Arrowheads and Improved support for UML

SmartDraw 4 adds twelve new built-in arrowheads and allows any of the standard arrowheads to be replaced by a user-defined symbol. The new arrowhead styles, the support for tables, and a new collection of UML symbol libraries improve SmartDraw's support of Universal Modeling Language (UML).

Keyboard Navigation and the Support for Forms

SmartDraw 4 supports navigation between shapes using the keyboard. The tab key moves the selection from shape to shape. If the currently selected shape is open for text editing, tabbing opens the next shape for text editing.

The combination of keyboard navigation, support for tables, and automatic text resizing make SmartDraw 4 an excellent tool for creating and filling-in business forms.

Ungrouping of Imported Images

You can ungroup imported Windows metafile images into native SmartDraw objects, allowing you to edit images created in other programs.

Opening of Files from other Flowchart Programs

The ability to ungroup metafiles means SmartDraw 4 can import files from other flowchart programs like **Visio®**, **MicroGrafx Flowcharter®**, **EasyFlow®**, **Flow Charting PDQ®**, and others.

SmartDraw 4 has special ungrouping features for translating metafiles (WMF files) from flowcharting software into editable SmartDraw drawings. These include placing text inside boxes, associating arrowheads with lines, and replacing line segments with segmented lines.

Multiple Selection Tool



SmartDraw has always supported selection of more than one object via shift clicking with the mouse. Now selection of more than one object is made even easier with the new multiple-select cursor. Selecting this button on the toolbar makes your clicks behave as if the **Shift key** were depressed, without your having to touch it.

Text Attributes

The new **Text Entry Properties** feature gives you control over the gap between the edge of a shape and the text inside it. It also allows you to freeze the text inside a shape (so it can't be edited) and to make text editing within a shape available with a single mouse click.

SmartDraw 4 Professional Features

Professional

SmartDraw 4 Professional has the following exclusive features.

Spelling Checker

SmartDraw's spelling checker works similarly to the one in Microsoft Office. Words are checked in the background as you type, and misspelled words are underlined with a red wavy line. Right clicking on a misspelled word presents a menu of suggestions.

You can also check the spelling of an entire document upon command. Automatic correction of popular misspellings is supported, and you can add your words to your own custom dictionary.

Most European languages (including British English) are supported, and you can switch languages on the fly with a single menu command.

Advanced Import and Export Filters

SmartDraw Professional gives you access to Postscript Import and Export, plus the vast libraries of technical symbols in AutoCAD format. It supports many more file import and export formats than the regular edition of SmartDraw. These include:

- Encapsulated Postscript (EPS)
- AutoCAD (DXF)
- CGM
- HPGL
- PDF
- Adobe Illustrator
- CorelDraw
- MicroGrafx Draw
- Visio (Import Only)

OLE Client Support

SmartDraw Professional is an OLE client. As with Microsoft Word and other Office applications, you can insert graphs, WordArt, Spreadsheets and other OLE objects into SmartDraw Professional drawings.

In SmartDraw an OLE object behaves like any shape. It can be flipped, rotated, moved and re-opened for editing by the program that created it.

OLE objects in SmartDraw drawings can also be added to SmartDraw symbol libraries, while retaining their OLE object properties. Dragging an OLE symbol (like a graph, for example) from a library into your SmartDraw drawing creates an OLE object that can be edited by the program that created it.

The Microsoft Office Companion

If you have Office installed on your system, the Office Companion adds many more exciting features to SmartDraw Professional, including the ability to add bitmaps, graphs, equations and WordArt®, directly from the SmartDraw toolbar. The Companion also includes galleries of pre-designed graphs, text styles, and equation symbols, placed at your fingertips in SmartDraw libraries.

Global Search and Replace

SmartDraw Professional supports global search and replace for an entire drawing.

Installing SmartDraw

Before you can run SmartDraw, you must first install it by running the **Setup Program**. There are three ways you can obtain this file:

- By purchasing it and downloading over the Internet.
- On CD
- On 3.5" Diskettes

Internet Download

If you downloaded SmartDraw over the Internet, you chose either SmartDraw 3 or SmartDraw 4 when you downloaded. To install the program you purchased, run the program you downloaded and follow the instructions.

Make a backup of the install program you downloaded! You can do this either on your normal backup system, or on diskettes using the Windows Backup program found in **Start** under **Programs/Accessories/System Tools**.

CDROM

If you purchased SmartDraw on CDROM all you have to do is put the CD in your CD drive, and the **setup.exe** program will start automatically. If this does not happen, you must run setup.exe manually.

The easiest way to do this is to use the Run command. This is found under the Start button in Windows 95 and under the Windows Program Manager's File menu in Windows 3.1. Run presents a dialog that prompts you for the name of the program you want to run. If you placed the SmartDraw CD in Drive D, just type:

D:\SETUP

Follow the directions displayed by the Setup program. The setup program will install either SmartDraw 3 or SmartDraw 4 based on your operating system.

Diskettes

To install SmartDraw from diskette, place the program diskette labeled **Disk 1** in the floppy drive and run the Setup program. You must run Setup using Windows.

The easiest way to do this is to use the **Run** command. This is found under the **Start** button in Windows 95 and under the Windows Program Manager's File menu in Windows 3.1. **Run** presents a dialog that prompts you for the name of the program you want to run. If you placed the SmartDraw disk in drive A, just type:

A:\SETUP

Follow the directions displayed by the Setup program. The setup program will install either SmartDraw 3 or SmartDraw 4 based on your operating system.

Installing SmartDraw on a Network

To install SmartDraw on a network server, simply install it on the server in the normal way described above. For each client that will have access to the server, create a shortcut (or icon) for SmartDraw on the client system and run the program once. SmartDraw will install itself properly on the client system.

You must have a multiple-user (network) license to share one copy of SmartDraw between multiple users on a network.

Running SmartDraw

Once installed, SmartDraw is added to your start menu, and a SmartDraw icon is added to your desktop. To run SmartDraw, double-click on this icon, or run SmartDraw in the same way that you run your other applications.



The Welcome Dialog

The first time you run the program you are presented with the **Welcome Dialog**.

This lets you choose how to start your first drawing and shows you useful tips for using SmartDraw.

You can start by creating a new drawing or by opening an existing drawing file. If this is the first time you have used SmartDraw, you will probably want to create a new drawing.

Later, once you have a list of previously saved drawings, typing **Enter** at the Welcome dialog opens the last one you were working on.

You can make one of these choices permanent, and skip showing Welcome dialog each time you run the program, using the Options dialog. (See [The Options Dialog](#)). As a shortcut to this, you can un-check the **Show Welcome Dialog** checkbox at the bottom, and you will automatically create a new drawing each time you run SmartDraw.

The **Show Hints** checkbox controls whether or not you see beginner's hints while you are using the program. These are dialogs that pop up automatically when you try to use certain features of the program for the first time. They attempt to explain what you are about to do and provide a direct route to more detailed help.

Each hint will only appear once in each SmartDraw session, and the hints can be switched off from any Hint dialog. We recommend that you leave the Hints switched on the first few times you use the program.

Once switched off, hints can be switched on again using the Options dialog .

Getting Help

SmartDraw has extensive on-line help. There are several ways to access the help system.

Help Menu

The Help menu shows several commands that open the help window.

Contents shows the table of contents. Double clicking on any of the underlined items takes you to the screen for that topic.

Index presents the index to the help system. If you start to type the name of the subject you are looking for, the scrolling list of topics will show any words that match.

Using Help opens the help files for the Windows help application. If this is not installed on your system (by Windows), this command will not work.

Help in Dialogs

All dialogs contain a help button. Pressing this button, or typing the **F1 key**, opens the help system showing a screen that describes that dialog's controls.

Context Sensitive Help

When a dialog is not showing, pressing **Shift-F1**, or pressing the help button on the toolbar (shown at left), puts you in the **help state**. While in this state, selecting any of the menus, or pressing any of the buttons in the toolbar or library window, opens Help with the appropriate screen displayed. The help state is canceled after you click or show a help screen.

Tips

Tips are helpful hints that bring some of the richer features of the program to your attention. A new tip is shown each time that you see the Welcome dialog . You can also look at tips at any time using the **Tips** command under the Help menu. This presents the **Tips Dialog**.

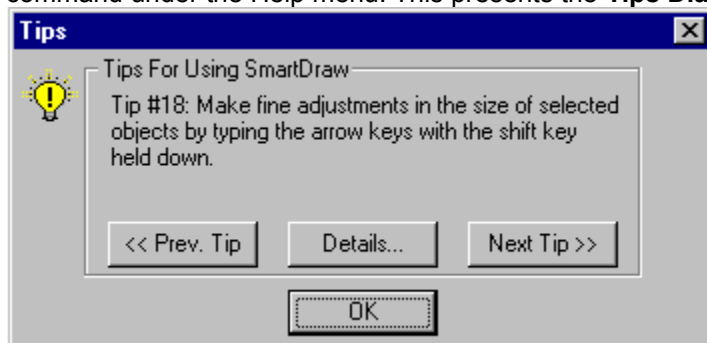

The Tips Dialog

You can browse through all the tips using the **Next** and **Previous** buttons. The **Details** button brings up a help screen describing the tip in more detail.

Creating a New Drawing



A new drawing is created when you start the program, when you press the **New Drawing** button on the toolbar, or when you use the **New...** command under the File menu. In all cases, SmartDraw shows the **New Drawing Dialog**.

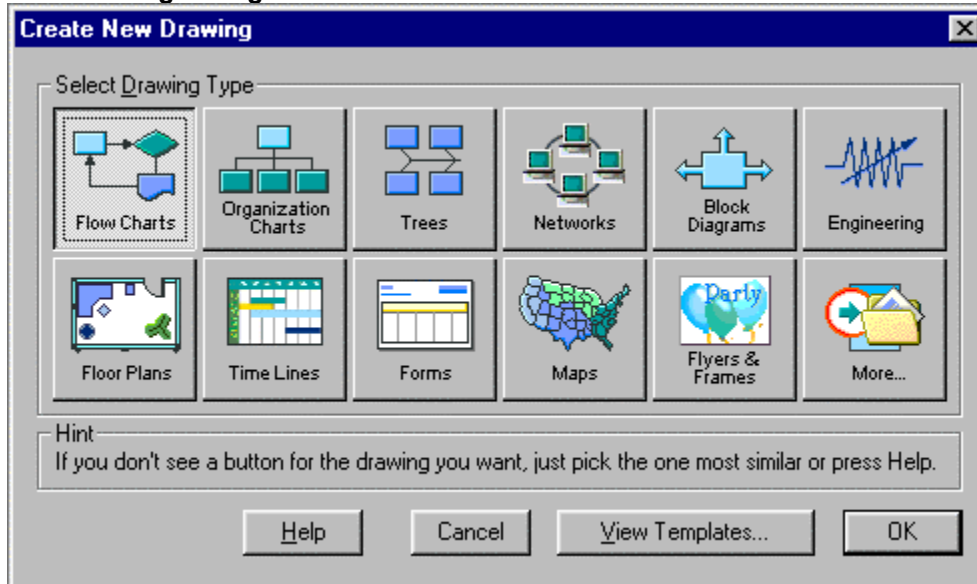

The New Drawing Dialog

This shows a button for each type of drawing you can create with SmartDraw.

If you double-click on a picture button (or select one with a single click and then press OK) you create a new *empty* drawing with no shapes, but with the correct settings for this kind of drawing. These include ruler settings, line- and shape-linking settings, and sometimes a special toolbar for this type of drawing.

If you don't see a button for the type you want, select the one that seems most similar.

The **View Templates** button allows you to select a SmartDraw Template. A template is a drawing that already contains objects, as well as the correct settings and toolbars. Some drawing types do not have templates. In this case the **View Templates** button is gray. Others, such as Maps, have only templates, and you cannot create an "empty" drawing of this type. In this case the **OK** button is gray.

There is a detailed discussion of how to modify the buttons, or create your own, in [New Drawing Buttons](#).

Selecting a Template

Pressing the **View Templates** button in the **New Drawing** dialog takes you to the **Template Dialog**.

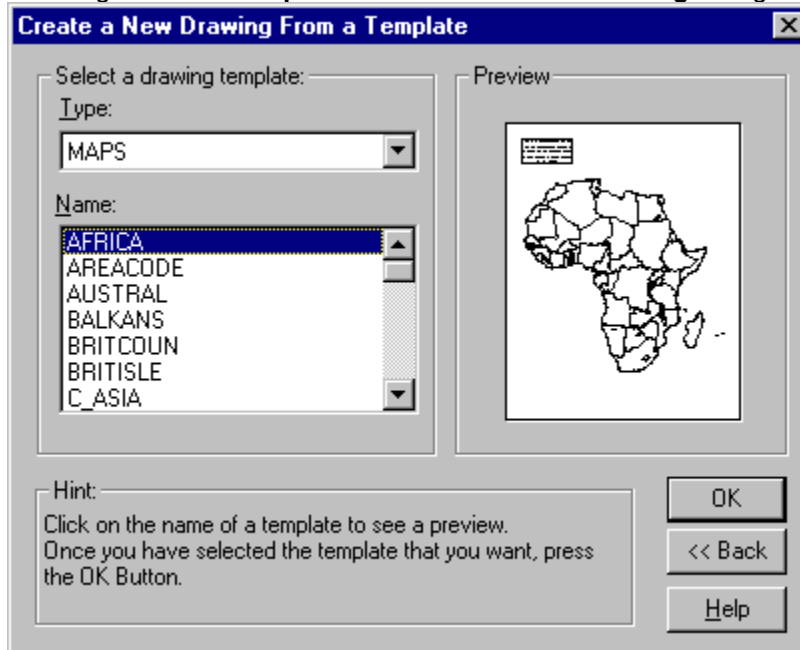

The Template Dialog

The **Template Dialog** allows you to preview each template by selecting its name in the list. Once you have made your selection, pressing the **OK** button creates a new untitled document that has the same settings and contains the same shapes as the currently selected template.

You can also change the *drawing type* from the **Template Dialog** using the drop-down list.

Templates are described in more detail in [Creating SmartDraw Templates](#).

Each drawing has its own scrollable window. Normally drawing windows are opened so that they fill the entire SmartDraw program window (they are maximized). Depending on the settings on your system, you may have up to 32 different drawings open at the same time.

Closing and Saving Drawings

You may close a drawing window using the **Close** command under the File menu, or by clicking the window's close box in the title bar. Any changes you have made to your drawing DO NOT become permanent unless you save them. If you have made changes since you last saved, you are reminded to save your drawing before the window closes.



You can save drawings to a file on your hard disk using the **Save** or **Save As** commands under the File menu. Pressing the **Save File** button on the toolbar also saves the drawing.

New drawings must be given a name before they are saved. You do this with the standard **Save Dialog** you see in all Windows programs.

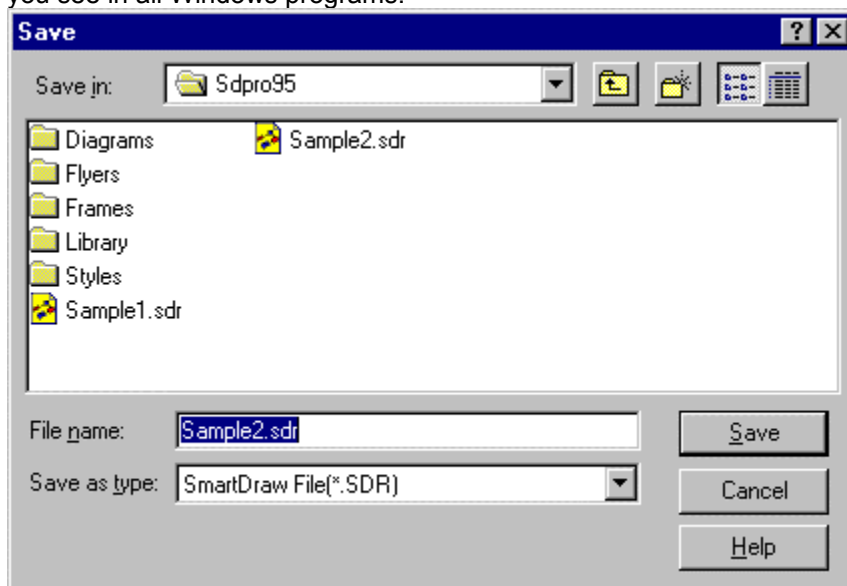

The Save Dialog

For drawings that have been saved, and already have a file name, the **Save As** command can be used to save the drawing to a different file name. The **Save** command saves the drawing to same filename.

The **File Name** box lets you type in a name for the file, or pick one from are above by clicking on it. If you type the name and do not supply a three letter extension at the end (like .SDR), the current extension is added automatically. Names can be longer than 8 letters.

The area above the file name field is an explorer window. To search in other folders, click on the names shown in this window or the drop down list above it. Use the context sensitive help in the dialog itself to learn about the details of this standard behavior.

SmartDraw remembers the last folder you used to open or save a file with this dialog and automatically sets the folder there when you use it again.

The **Save As Type** control changes the extension of the files shown in the **File Name** list and the type of the file saved. **SmartDraw File** has an extension SDR and is the usual choice.

Using **SmartDraw Template** saves the current drawing as SmartDraw Template. This is the same as a normal file but with the extension SDT. When template files are opened, an untitled copy is made and the original is left closed. After saving a file as a template, the drawing retains its current file name.

The Template Dialog shows only templates that are stored in folders inside the **Templates** folder in the program folder. If you want to create your own template, be sure to save it in one of these folders, or create a new folder of your own (using the Windows file manager) to create a new draw type and save it there.

You can also export your drawing to any one of many different graphic formats, using the **Save As** dialog. Just choose a format using the **Save As Type** control. The Export command on the file menu performs the same function.

The OK button confirms your choice of file and puts away the dialog. The Cancel button puts away the dialog without selecting a file.

Opening an Existing Drawing



Once a drawing has been saved to a file on disk, you can re-open it using the **Open** command under the File menu or by pressing the **Open File** button on the tool bar. These commands show you the standard Windows **Open Dialog**.

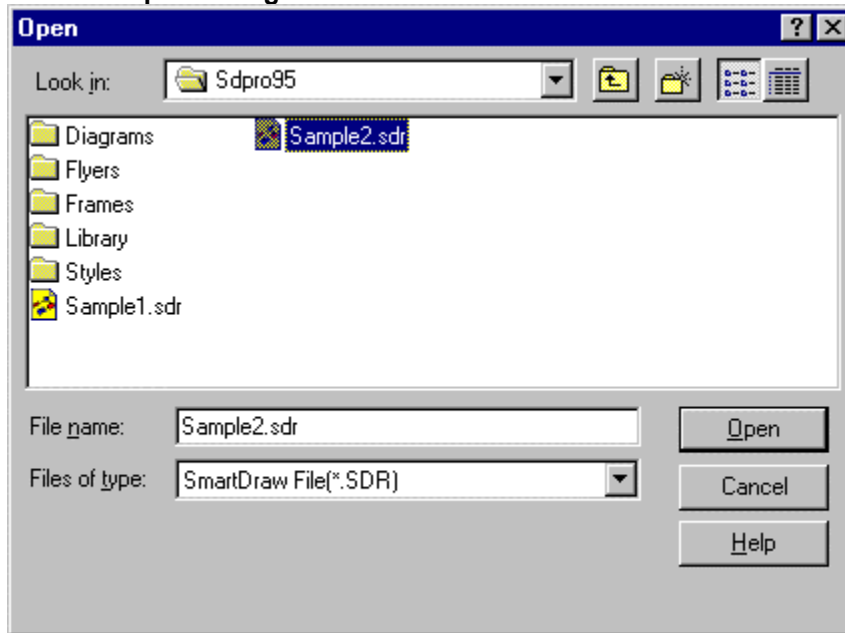

The Open Dialog

You can also open the SmartDraw drawing files by simply dragging them from the Windows Explorer and dropping them anywhere in the SmartDraw window.

The **File Name** box lets you enter a name for the file to open, or you can pick one from the area above by clicking on it. If you type the name and do not supply a three-letter extension at the end (like .SDR) the current extension is added automatically.

The area above the file name field is an explorer window. To search in other folders, click on the names shown in this window or the drop down list above it. Use the context sensitive help in the dialog itself to learn about the details of this standard behavior. SmartDraw remembers the last folder you used to open or save a file with this dialog and automatically sets the folder there when you use it again.

The **Files of Type** control changes the extension of the files shown in the explorer window. Normally this is **SmartDraw File (SDR)**. The second choice, **SmartDraw Template**, opens files with the extension **SDT**. These files are the same as SDR files but they open as an untitled copy, leaving the original intact. This is useful if you want to create files with your own initial settings, or with a set of initial shapes, to serve as the starting point for other drawings.

SmartDraw comes with a broad selection of sample templates. The best way to open these is to use the [New Drawing Dialog](#) which allows you to browse through each category and to see a "thumbnail" of each template before you open it. You can open the **New Drawing** dialog by using the **New...** command under the file menu.

You can also choose to [open files from other flowcharting programs](#). You must first export these files from their native programs in **Windows Metafile Format (WMF)**. SmartDraw cannot open these other

programs native file format, since they are not made public, (with the exception of Visio when using the Professional Edition of SmartDraw).

The **OK** button confirms your choice of file and puts away the dialog. The **Cancel** button puts away the dialog without selecting a file.

Drawings and Windows

Each SmartDraw drawing has its own **document** window. SmartDraw is a Multiple Document Interface (MDI) application, and up to 32 drawing windows can be open at the same time.

When these windows are maximized, as is usually the case, the front-most window covers the entire screen, or program window, so that none of the other drawing windows can be seen. This can be changed using the commands under the Window menu.

Cascade Windows and **Tile Windows** commands both show all the drawing windows, the former by overlapping them, the latter by dividing up the program window.

The remaining items on the Window menu are the names of the open drawings. Selecting one of the items brings that drawing to the front.

All menu, and other, commands apply only to the front-most drawing.

Right Mouse Button Menus

Clicking with the right mouse in the document window displays a **context-sensitive** menu. The contents of this menu depend on what you have clicked on. You will find this a convenient shortcut to many of the features found on the main menu bar.

The Program Toolbar

The **Program Toolbar** lies above any drawing windows and below the menu bar.



The Program Toolbar

The program toolbar can be shown or hidden by selecting the **Show Toolbar** item under the View menu.

The buttons on the top row are shortcuts for menu commands. You can find out what each one does by holding the cursor over a button for a second or more. A small yellow window pops up describing its purpose. This is called a **ToolTip**.

The buttons in the second row are used for drawing. One of these buttons appears to be pushed in, indicating that this button is selected. The button selected determines what will happen when you click with the mouse in the drawing.



When the *arrow* button is selected, clicking in the drawing selects, moves or resizes existing objects.



When the *multiple selection* button is selected, clicking on an object selects it without deselecting other selected objects. This makes it easy to select more than one object at a time.



When the text button is selected, clicking on a shape opens it for text entry. If you click in the background of the drawing, you create a new background text object.



When the line button is selected, clicking and dragging in the drawing draws a straight line. Dragging and Dropping also draws a line.



When the arc button is selected, clicking and dragging in the drawing draws an arc of a circle. Dragging and Dropping also draws an arc.



When the segmented line button is selected, clicking and dragging in the drawing draws a segmented line. Dragging and Dropping also draws a segmented line.



When the curve button is selected, clicking and dragging in the drawing draws a curved version of a

segmented line. Dragging and Dropping also draws a curve.

When the **Connector** button is selected, clicking and dragging in the drawing draws an *Automatic Connector*. Automatic Connectors are described in more detail [Using Automatic Connectors](#).



The remaining buttons draw the shape shown on their face. The shape buttons can be configured to show any of the 24 standard shapes, and to control the default size and proportions of the shapes that are dragged and dropped. You can change the button settings, by double clicking on the button, or selecting the **Toolbar** item under Tools menu. This is described [Changing the Program Toolbar](#).

See [The Document Toolbar](#).

The Document Toolbar

A **Document Toolbar** appears at the top of a document window. When the document is maximized, the document toolbar appears to be a third toolbar below the program toolbar.



Document Toolbar below the Program Toolbar.

A document toolbar is a **SmartDraw Library** window that has been dragged to the top a window and "docked" there. It behaves just like a library window and is fully customizable. Many of the built-in templates have their own specialized toolbar.

Document toolbars are described in more detail in [Document Toolbars](#).

Rulers and Grids

Rulers are normally displayed along the top and left edges of the drawing window.

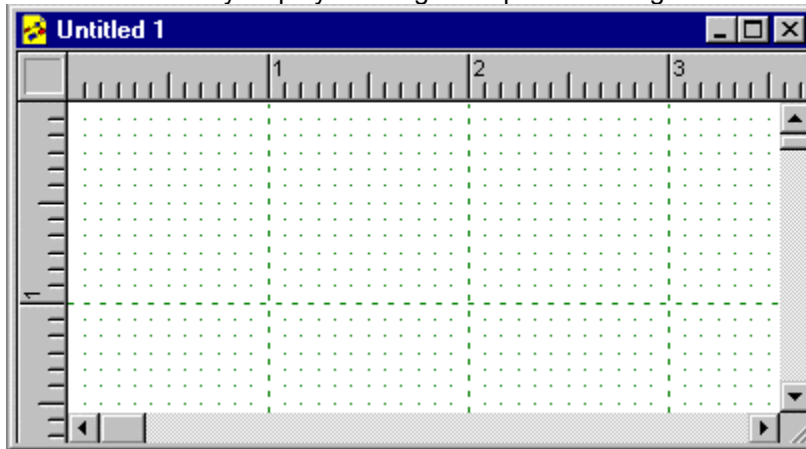

Drawing Window with Rulers and Grid Showing

The divisions on the ruler define the spacing of a grid that covers the drawing area. You can show or hide the grid using the **Show Grid** command under the View menu. The same grid (whether showing or not) controls the spacing of the snaps.

The top-left corner, where the rulers cross, shows a digital display of the current position of the cursor in the units of the ruler.

Clicking in a ruler displays a temporary dotted line, called a **Guide**, that follows the position of the cursor. This can be used to measure the position of an object in the drawing. Clicking in the corner, where the two rulers cross, and then dragging displays two of these lines forming a "cross hair" arrangement.

See [Setting the Ruler Scale](#).

Symbol Library Windows

Symbol Library Windows contain symbols that can be added to SmartDraw drawings, just like any of the standard shapes on the toolbar.

Groups of symbols are stored in **Libraries**. Libraries are usually groups of similar symbols that are used for a particular type of drawing. SmartDraw has dozens of libraries with symbols for flow charts, computer networks, floor plans, clip art, geometric shapes, and many more.

You use the **Libraries Menu** to find and open symbol libraries. The **Open Symbol Library** command presents the **Open Library** dialog.

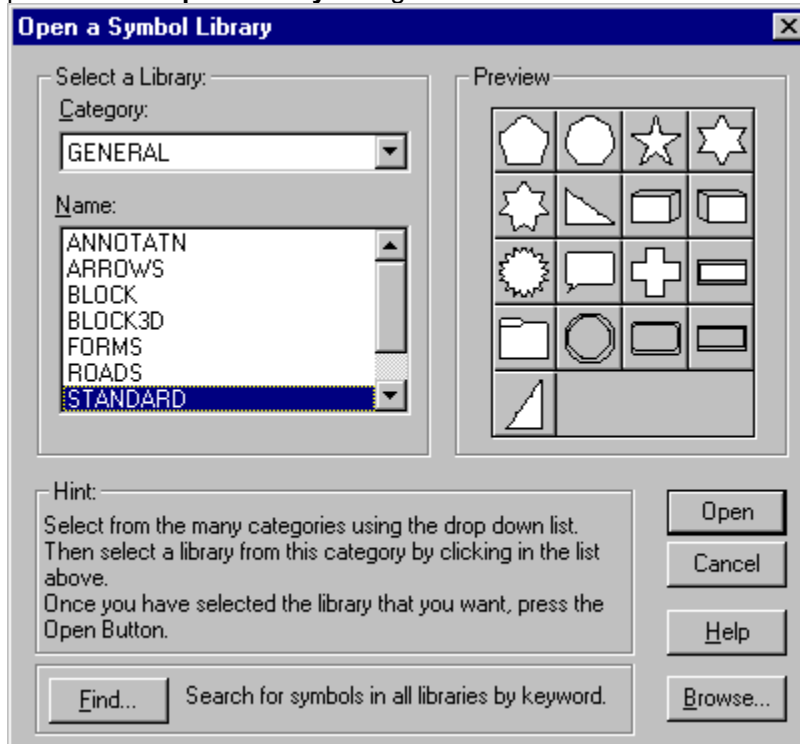

Open Library Dialog

The libraries are organized into categories, shown in the drop-down list. Selecting a *Category* shows a list of all the libraries in that category below in the scrolling list. Selecting a library shows a preview of its symbols.

You can also search for a symbol by name, using the **Find** button. This is discussed in more detail in [Libraries](#).

Once a library has been opened, its symbols are displayed in a **Library Window** that "floats" above the drawing. Up to 16 library windows can be open at the same time, each showing the contents of a different library. The Libraries menu shows the most recent libraries that were opened and shows a check mark next to the names of those that are currently open. Selecting one of these menu items either opens it or brings it to front.

Any library window that was left open when the last drawing was closed is always re-opened automatically (in the same location) whenever a drawing is opened again.

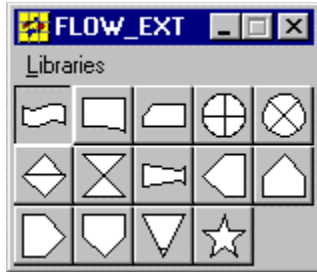

A SmartDraw Library Window

The library window shows rows of buttons, each displaying a different symbol from the current library. The name of the current library is shown in the window title bar.

Undo

Almost any change you make to a drawing can be undone using the **Undo** command, under the Edit menu.

When you undo, the undo menu item changes to **Redo**. Using Redo returns the program to its state before the undo command was used. Repeated use of Undo, toggles the program between the current state and the state before the most recent operation.

If the command is gray, there is no previous state to return to.



The Undo button on the toolbar can also be used to perform an undo or redo.

Changing the Page Size and Orientation

All SmartDraw drawings have the same 50x50 inch drawing area. This fixed area is divided up into "tiles" equal in size to the printable area of the printer paper currently selected.

Unless your drawing is large, you normally work only with one page in the top left corner of the 50x50 area. However, this system allows you to draw very large charts that flow across many pages, print them out on normal paper, and then join the sheets together to re-create the drawing at full size.

You can change the size and **landscape/portrait** setting of the pages using the Page Setup command under the **File Menu**. Just select a new paper size and orientation using the **Page Setup** dialog. This will not change your drawing area, but it will change the way the drawing is printed out. You can see the page boundaries in the drawing area as dotted lines. Change the **View** to **Fit to Window** to see this quite clearly.

Page Margins

Because SmartDraw drawings are often printed on several pages and then re-assembled again into one large chart, SmartDraw always prints on as much of the page as is allowed by the printer.

Most printers reserve a small margin of about ¼" on each page that cannot be printed on.

If your drawing fits onto just one page and you want larger margins than this, simply leave extra space at the edges of your drawing. You can center your drawing on the first page using the **Center Drawing on Page** command under the **Arrange** menu.

Storing Two or More Drawings in the Same Document

Because SmartDraw supports 24 or more pages per document, you may be tempted to put independent drawings on different pages in the same file.

Don't do this! Store each independent drawing in its own document.

The multiple page feature of SmartDraw is intended to allow you to draw one drawing, larger than a single page. It is not intended to allow you to put 6 different flowcharts in one file. Commands like Center Drawing on Page and Print on One Page assume that the contents of a file are one drawing. There is nothing to gain by storing multiple drawings in one file. Put all the drawings you want to print separately in their own drawing file.

If you have already put more than one drawing in the same file, it is easy to separate them using **Copy** and **Paste** as is explained in Copying and Pasting.

Default Settings

In SmartDraw you change the default characteristics (color, thickness, font, etc.) for new objects by changing the characteristics of an *existing* object.

When you change a property of an existing object, such as the fill color of a shape, the next shape you create will have this fill color automatically. When you change a property, you change the default setting for new shapes and lines at the same time.

The few exceptions to this rule are specialized settings that users are unlikely to want as a default.

You can also set the initial defaults for new drawings. This is described in [Designing Templates](#).

Exiting SmartDraw

You can exit SmartDraw by using the Exit command under the File menu. You can also click in the program window close box. Before the program quits, you are prompted to save any open drawings that have been changed.

The Basics of Flow Charting

Flow charts are diagrams that portray the flow of information and the decision-making process that controls the flow. While many styles of flow charting have developed, each with its own set of specialized symbols, most processes can be represented using just a few simple symbols.

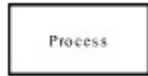

This represents an activity such as "signing a check", or "requesting a bid".



This represents an alternate type of process. You can use the two types of process symbols to classify processes into two groups: customer vs. supplier, for example.

This is used to represent a decision that must be made. Lines representing different decisions are often drawn coming out of some of the 4 different points in the shape.

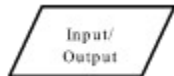

This symbol is used to represent information coming in and going out of the system, such as a customer order (input) or a product (output).



This symbol is used to represent printed information generated by the system such as an invoice or other report (output).



This symbol is used to connect multiple lines together, or when labeled with a letter, to indicate that the flow continues at the connector with the same letter on another page, or somewhere else in the system.

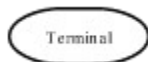

This symbol represents the starting or ending point of the system. It is usually labeled "Start" or "End".

SmartDraw Quick Tutorial: The Basics of SmartDraw in 12 Easy Lessons

What Can I Do With SmartDraw?

SmartDraw is the easy-to-use graphics program that takes the *drawing* out of drawing. With SmartDraw you simply **drag and drop** lines and shapes with your mouse to create beautiful, professional-looking drawings and diagrams:

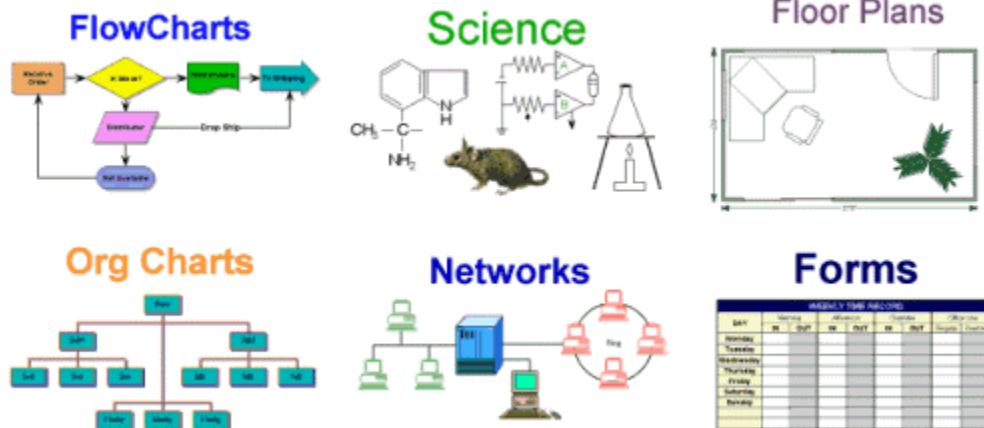

Plus:

- Circuit Diagrams
- Fishbone Diagrams
- Chemical Formulae
- Mechanical and Electrical Engineering Diagrams
- Maps
- Flyers, Invitations, Signs, Certificates
- Timelines
- Many other types of business and technical graphics

Drawing Made Easy

SmartDraw automatically aligns shapes, lines and text for you. Its built-in library of design styles lets you pick professional-looking color schemes, shadows, and textures with the click of a mouse. You'll find over 1500 ready-made shapes and images in the *Symbol Libraries*, and you can even add your own, for a truly limitless collection.

Working with Other Programs

SmartDraw works as a stand-alone program, and as part of the Microsoft Office, Lotus SmartSuite and other programs that support Object Linking and Embedding (OLE). You can insert a SmartDraw drawing directly into Microsoft Word for Windows with Cut & Paste, or with the Insert Object command.

[Tutorial Lesson 1: Starting the Program](#)

Tutorial Lesson 1: Starting the Program

When you run SmartDraw, you are presented with the *Welcome Dialog*. (A dialog is window that gives you choices.) You can choose to **Start a New Drawing** or **Open an Existing Drawing**.

If you **Start a New Drawing**, SmartDraw displays the **Create a New Drawing** dialog. You can start your drawing with a Template (a ready-made drawing that serves as a "starting point"), or you can simply click **OK** to start with an empty page.

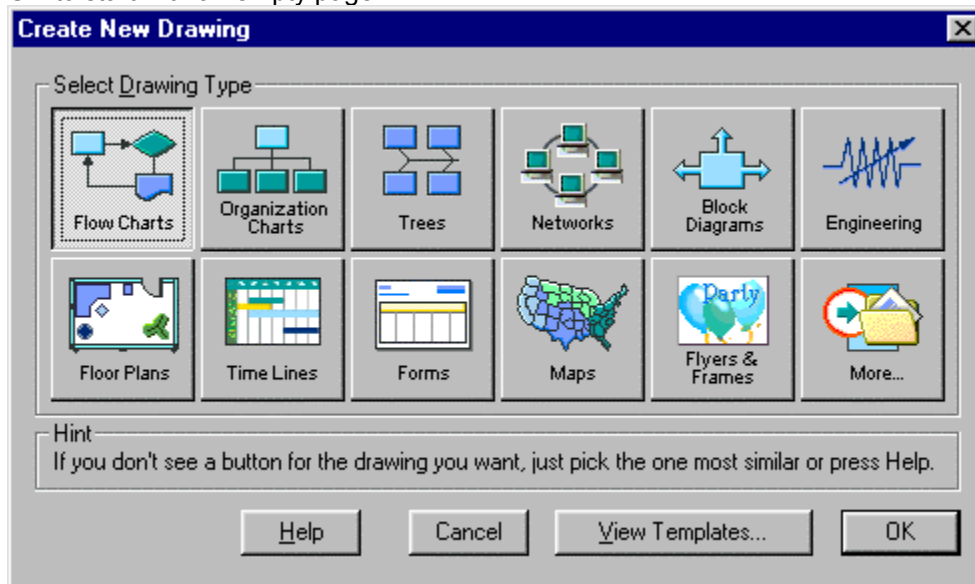

The "Create a New Drawing" dialog

If you don't see a button for the kind of drawing you want, you can press **More** to see additional types. If none of the available types are exactly what you want, just pick the one that's most similar.

To create a new blank drawing of any type, just click on the button for that type, then click **OK**. If you want to look at some ready-made templates for your chosen type of drawing, click "View Templates."

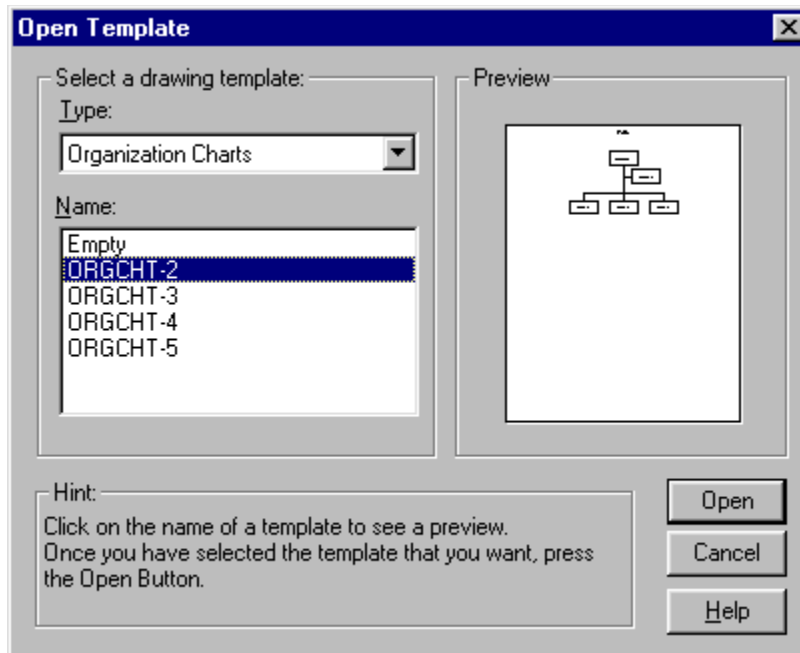

The Template Dialog

This displays the **Template Dialog**. You can choose from the list of templates available for your type of drawing. Finally, click **Open** to start your drawing with the chosen Template.

[<< Overview](#) [Next Lesson >>](#)

Tutorial Lesson 2: Basic Drawing

You begin most drawings by dragging *Shapes* from the Toolbar and dropping them on the page. With the left mouse button, click down on the desired shape on the SmartDraw toolbar; drag the shape into the drawing area, and release.

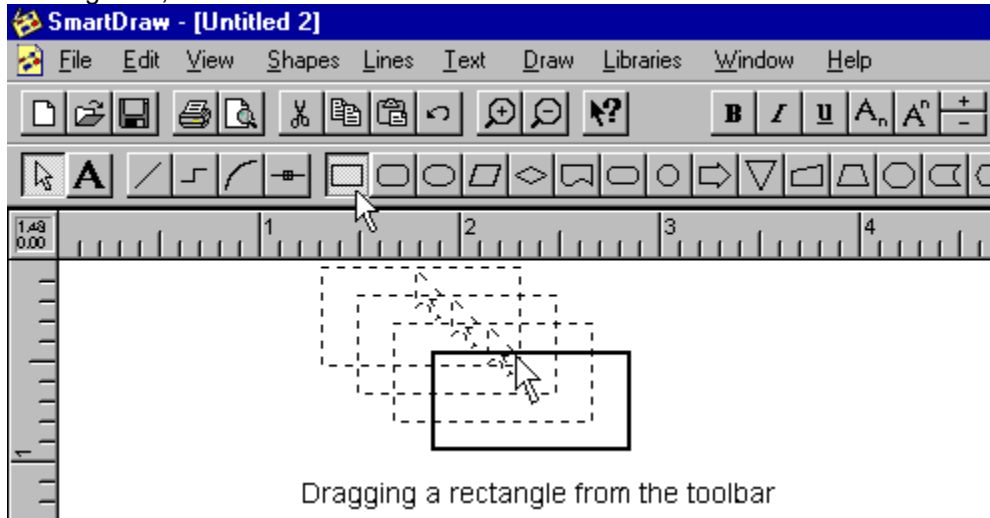

You can connect shapes with *Lines*. To connect two shapes with a straight line, click on the **Straight Line Tool**  on the Toolbar and release.

Now your cursor looks like a pencil.  Touch the pencil to the edge of one shape and click down with the mouse (you'll see black dots on the edge of the shape). Drag the pencil to the edge of another shape, and release.

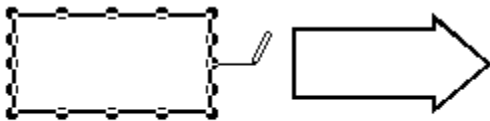

Starting a line from a shape

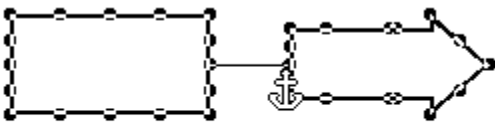

Anchoring a Line to a Shape

The black dots are *Connection Points*.

These points mark the places where a shape can be attached to a line or another shape. When you see Connection Points, you know your shape is ready to be attached to something. The *Anchor Symbol*  appears when a Line is *anchored* to the edge a shape. Once connected, lines and shapes stay connected, even if they are moved or stretched.

Shapes stay connected
when one is moved.

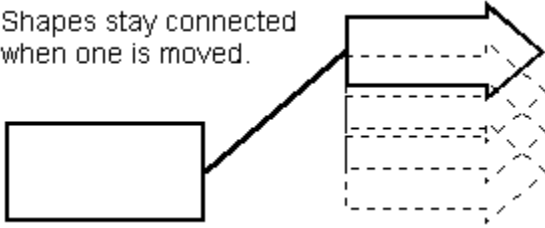

(Note: if your lines don't stay connected to your shapes, make sure "Allow Lines to Link," under the **Draw** menu, is turned on.)

Infinite Connect Points

If you want more Connect Points on a particular shape, you can choose **Connection Points** from the Shapes menu and select *Infinite Connection Points*. This allows you to attach lines to any point on the shape's perimeter.

Repeating an Operation (or, Making a Toolbar Button "Stick")

When you need to perform the same operation several times in a row (for example, drawing a series of lines), you need not select the same button on the Toolbar time after time. To make a Toolbar button "stick" in the selected position, hold the SHIFT key while you click on it.

[<< Previous Lesson](#) [Next Lesson >>](#)

Tutorial Lesson 3: Selecting Objects

Before you can move, stretch, color, or manipulate a line or shape on your page, you must *Select* it. The *Selection Tool*  (at the far left of the Toolbar) is your normal cursor. To *Select* a line or shape on the page, simply click on it with the Selection tool.

A selected object has black *Selection Handles* at the corners.

By dragging these handles, you can stretch or resize the object.

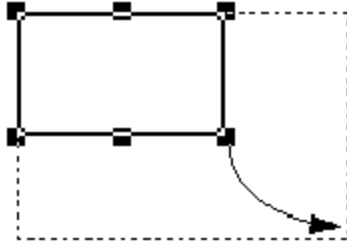

Growing an object

A selected object also has a *Rotation Handle*.

By dragging the rotation handle, a shape or line can be rotated to any angle.

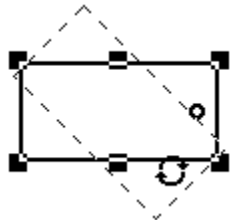
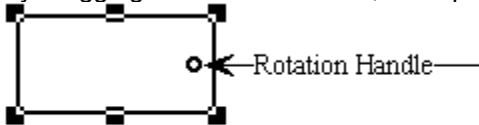

Selecting Multiple Objects

You can select several objects at one time. (This is useful for *Grouping* objects or for applying a common property, like a color, to all of them).

SmartDraw offers three ways to select several objects:

- 1) Hold the SHIFT key down while clicking on each object in turn with the normal selection tool.
- 2) Choose the Multiple Selection Tool  on the toolbar (beside the regular selection tool) and click on a series of objects with it.
- 3) Trace an imaginary "box" around the group of objects with the mouse. Click in an empty area of the page, hold the mouse button down, and drag the mouse until the objects you want to select are enclosed by the dotted box. Then release. All of the objects inside the box will be selected.

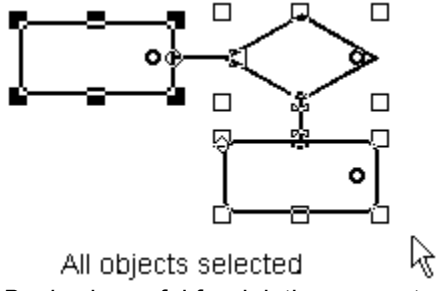
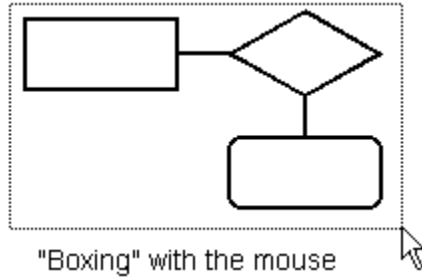

Boxing is useful for deleting unwanted objects from your page. Simply trace a box around the area you want to delete, then hit the delete key.

Select All

You can select all the objects in your drawing at once by choosing *Select All* from the **Edit** menu.

[<< Previous Lesson](#) [Next Lesson >>](#)

Tutorial Lesson 4: Using Lines

SmartDraw has four basic types of lines.

The *Straight Line*  draws a straight line between two points. In Lesson 1, we connected two shapes with a straight line. You can also connect lines to other lines.

The *Arc*  draws a section of a circle, of any size and curvature you want. You can bend the arc (using its handles) create anything from a straight line, to a complete circle of any desired radius.



Some of the things you can do with an Arc

The *Segmented Line*  attaches itself perpendicularly to objects. It travels from point A to point B in straight segments with 90-degree turns. (Don't worry if it flops around while you're drawing it. When you finally anchor it, it will fall neatly into place.)

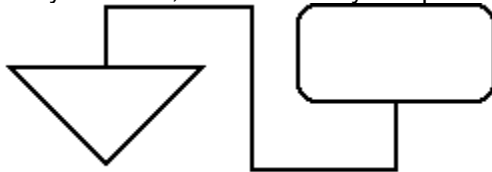

A Segmented Line connecting two shapes

The *Curved Line*  attaches itself perpendicularly to objects, and it travels from point A to point B in a smooth curve.

<< Previous Lesson Next Lesson >>

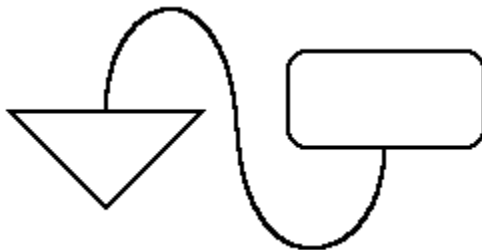

A curved line connecting two shapes

Change Line Shape

Any line in your drawing can be instantly converted to a line of another type by using the *Change Line Shape* command under the **Lines** menu.

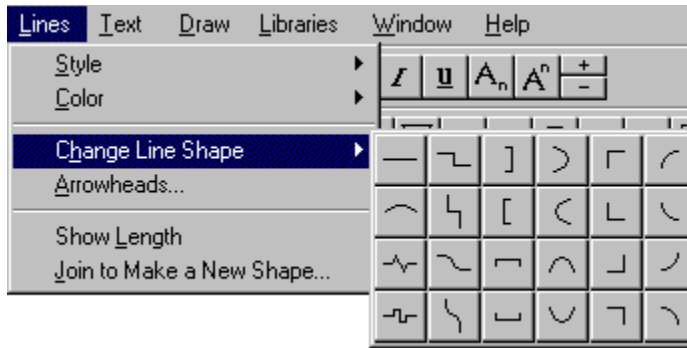

[<< Previous Lesson](#) [Next Lesson >>](#)

Tutorial Lesson 5: Adding Text to Your Drawings

SmartDraw makes it easy to add *text* to your drawings. If you want the text to appear inside an object, simply select the object (click on it) and start typing. Your text will automatically appear inside the object, and it will stay there even when the object is moved.

If you type more text than the object can hold, the text will automatically shrink (to a minimum size that you can control). Or, if you choose, your shapes can grow to accommodate more text as you type. You control this behavior using the **Text Entry Properties** command under the Shapes menu.

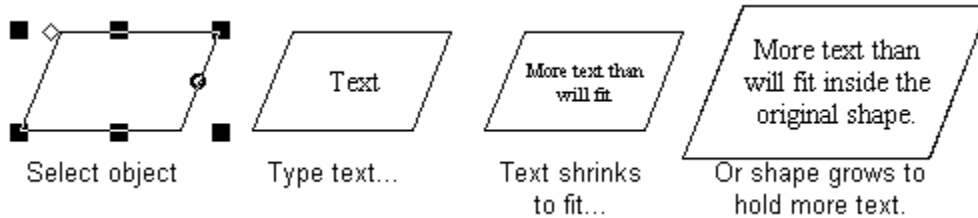

By default, your text will appear in the center of your objects. But you can always change the position and alignment of the text with the *Alignment* feature on the **Text** menu.



The text alignment menu

Editing Text

To modify a piece of existing text, double-click on it to enter the *Editing mode*. All of the normal Windows text editing conventions apply: Dragging with the mouse selects text. Selected text can be cut, deleted or copied. The font, size, style and color of selected text can be changed using commands on the Text menu.

Adding Text to Lines

SmartDraw makes it easy to label the lines in your drawings. As with shapes, you can add text to any line by selecting the line (clicking on it) and typing text.

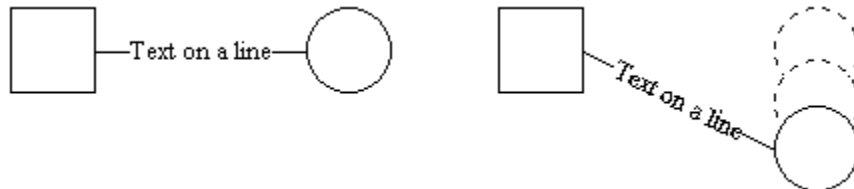

The text stays attached to the line, even when the line or its adjoining shapes are moved.

Background Text Objects

Text in SmartDraw does not have to be attached to a shape or line. You can create *Background Text Objects*, free-floating, independent objects that can be moved, rotated, or repositioned anywhere in your drawing.



To create a Background Text Object, first select the Text Tool  by clicking on it. Then click once anywhere in the empty background of your drawing. A blinking "insertion cursor" will appear. Enter your text, then click once in an empty area of your drawing to end the text entry session. Any text you typed will become a free-floating object. You can move, rotate, or reposition this text object anywhere in your drawing.

[<< Previous Lesson](#) [Next Lesson >>](#)

Tutorial Lesson 6: Colors, Shading, Borders, Arrowheads

You can fill a SmartDraw shape with color or change the weight, style and color of its borders. Select the shape, then choose the appropriate command from the **Shapes** Menu.



Basic Shape



Heavy Border



Fill Color

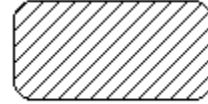

Shading

Lines can be modified using the **Lines** menu. You can change the weight and style of a line, or put arrowheads on it with the *Arrowheads* command. Each end of a line can have a different kind of arrowhead.

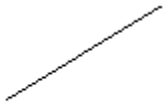

Basic Line



Heavy Style

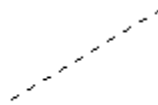

Dash Style



Arrowheads

[<< Previous Lesson](#)

[Next Lesson >>](#)

Tutorial Lesson 7: Automatic Connectors (the Easy Way to Draw Perfect Charts)

The *Automatic Connector*  is a special kind of line that automatically connects several shapes together into evenly-spaced patterns.

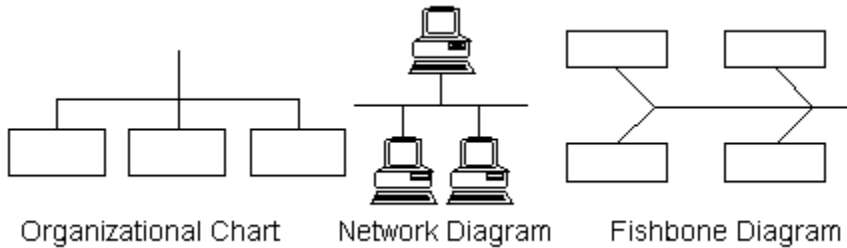

To use a new connector, drag and drop a connector  from the toolbar onto the page. Then drag a shape from the tool bar and drop it on the connector, so it looks like this:



Then drag another shape to the connector, and another, so it looks like this:

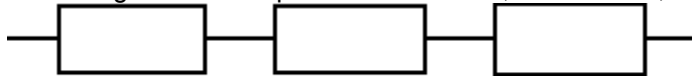

Three boxes on a Connector

The connector arranges the shapes in a straight line and spaces them evenly.

To change the connector's shape, select the connector line, then choose **Change Connector Shape** from the **Lines** menu. Choose from the array of connector shapes:

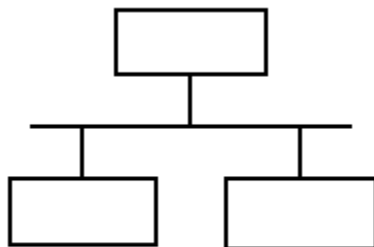
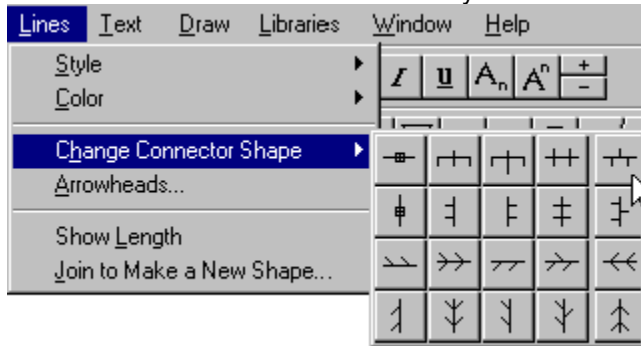

The result

Loose Ends

The ends of the connector stick out so they can be attached to other objects. To get rid of the loose ends, select the connector line, then grab the end and tuck it under the nearest line or shape.

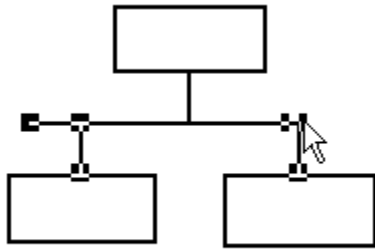

Tucking away a loose end

To get the end back, select the connector and pull the end out from the nearest line or shape.

Lines (and connectors) can be attached to a connector to make a hierarchy of levels.

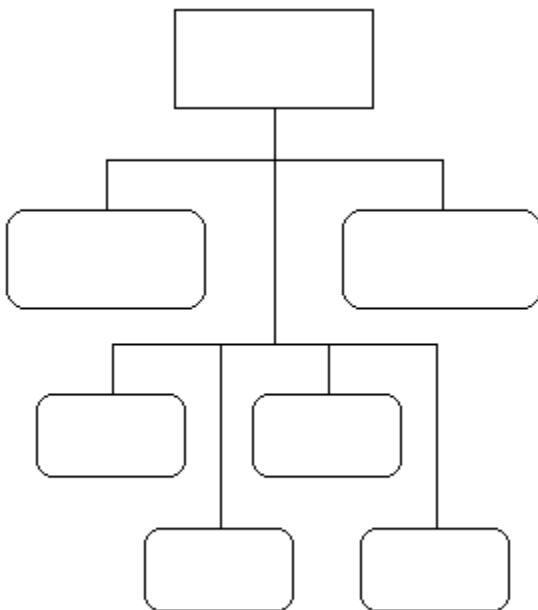

Organizational chart with 2 connectors

Adding Shapes to a Connector

When a shape or line is moved near a connector, *Link Points* appear, and the outline of the moving object jumps to the closest link point, showing its position if linked.

Releasing the mouse attaches the object to the connector, inserting the object at the link point.

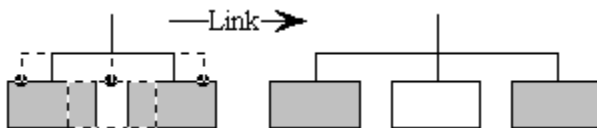

Linking to a Connector

Moving a shape away from the connector disconnects it, and the shapes still linked to the connector draw together to fill the space.

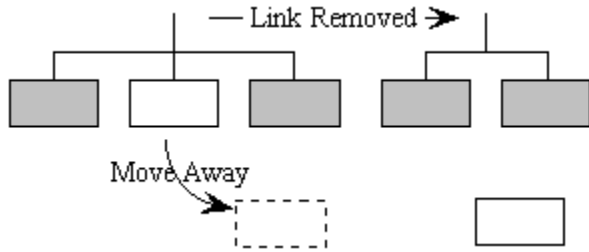

Breaking a Link to a Connector

Dragging a shape from one link point to another changes the order of the shapes.

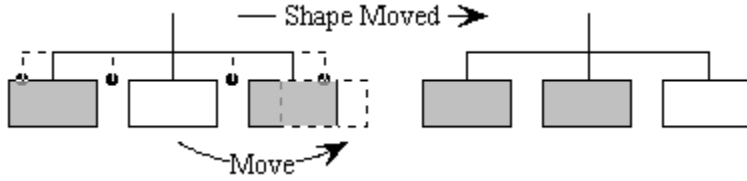

Re-arranging a Link to a Connector

[<< Previous Lesson](#) [Next Lesson >>](#)

Tutorial Lesson 8: How to Line Things Up

SmartDraw can automatically arrange the objects in your drawings into neat, regular patterns. First, Select the objects you want to arrange. Do this by clicking on each object in turn with the Multiple Selection Tool.

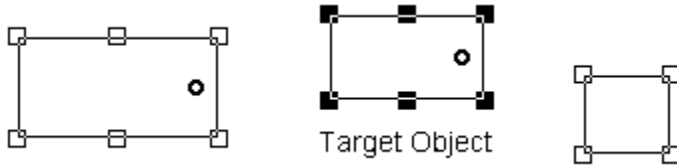

The last object you click is called the *Target Object*. It has black selection handles. When you use *Align* or *Make Same Size* (under the **Arrange** menu), all the selected objects will be aligned or re-sized to match the Target Object.

When you choose *Space Evenly*, the objects at each end of a series stay fixed, and the others are spaced evenly between them.



Results after using: Align, Make Same Size, and Space Evenly

Using Grid Snaps

Behind the SmartDraw page is a *Grid*, an invisible set of lines that can help align your objects. To see the Grid, select *Show Grid* from the **View** Menu. When you draw with *Use Snaps* turned on (**Arrange** menu), the objects in your drawing automatically align themselves with the nearest Grid line. This makes it easy to get straight lines and neat arrangements.

Using the *Define Rulers and Grid* command (**View** menu), you can choose which point in your objects align with the grid (you can snap to either the *center* or *top left corner*).

To position your objects freehand, without using to the grid, turn off *Use Snaps* under the **Draw** menu.

Making Fine Adjustments in Position

To move any line or object in the smallest possible increments (1 pixel at a time) select the object you want to move, and "nudge" it with the **arrow keys**. This technique is much more precise than moving with the mouse.

Other Commands on the *Arrange* Menu

- **Flip** (mirror) an object.
- **Rotate** an object to a specific angle (permitting greater precision than the manual *Rotation Handle*.)
- **Send to Back**, or **Send to Front**. If the object you want is hidden behind another, select the obstructing object and *Send to Back*.
- **Allow Lines to Link** - When this is on, lines "link" and stay connected to lines or shapes.
- **Allow Shapes to Link** - When this is on, shapes "link" and stay connected to each other.

[<< Previous Lesson](#) [Next Lesson >>](#)

Tutorial Lesson 9: Grouping and Un-Grouping Objects

Sometimes several objects are more conveniently handled as a *Group*. When objects are **Grouped**, they are treated as a single unit. They maintain their positions relative to each other, even when moved or rotated. A change made to one applies to all.

To *Group* several objects, first select them all (using the Multiple Selection Tool). Then select **Group** from the **Arrange** menu.

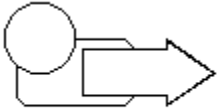

Separate Shapes

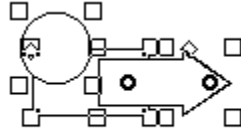

All Selected

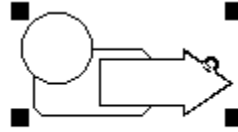

After "Group"

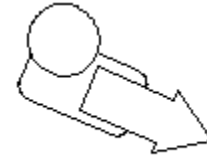

Rotated Group

Once Grouped, the objects can no longer be selected individually. If you rotate or re-size a group, all the objects rotate or re-size together. If you change a property (like a color), all objects in the group change.

To use the Grouped objects individually, you must *UnGroup* them. Select the Group, then pick **UnGroup** from the **Arrange** menu.

[<< Previous Lesson](#) [Next Lesson >>](#)

Tutorial Lesson 10: Using the Libraries

SmartDraw has dozens of **Symbol Libraries**, containing special shapes, objects, and pieces of clip-art ready to be dropped into your diagrams.

You can open a Library by clicking on the Open Library button  on the Toolbar, or by choosing **Open SmartDraw Library** from the **Libraries** menu. This displays the Open Library Dialog:

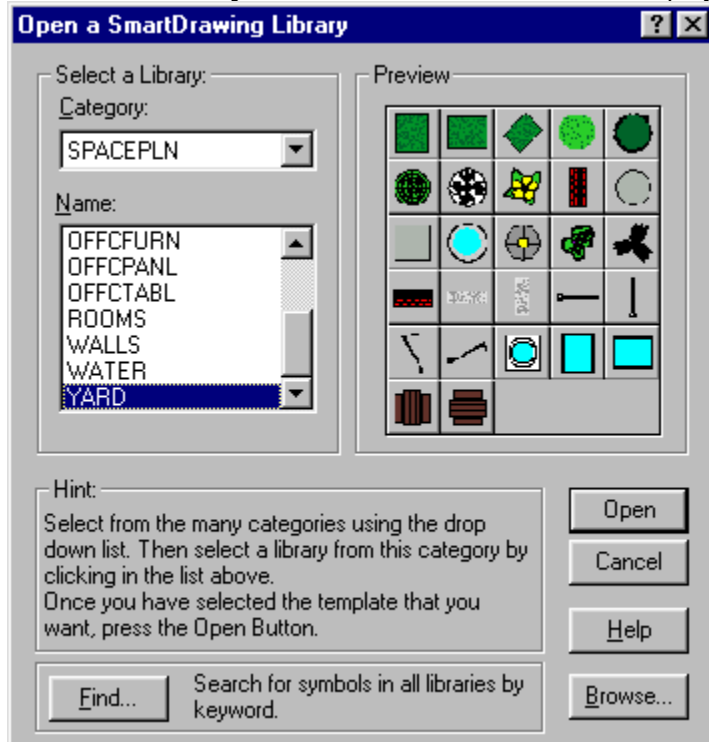

The Open Library Dialog

First choose the library **Category** from the upper list box, then choose the library **Name** from the lower list box. As you browse through the libraries, a *Library Preview* appears at the right. Open the desired library by clicking the **Open** button.

The newly opened library floats above your document. You can move it by dragging on the title bar of the library Window.

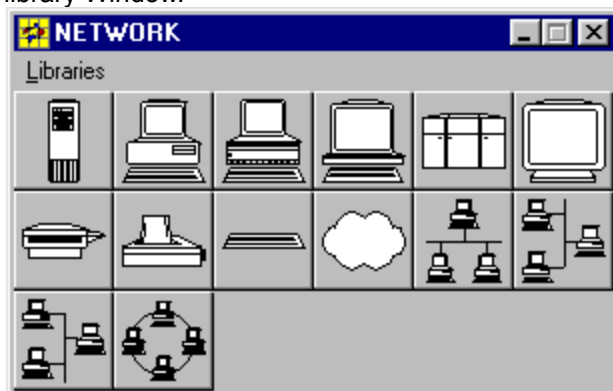

A floating Library Window

Docking

If you drag a library window to the top of your document window, it will *Dock* and become a *Document Toolbar*. You can *Detach* a docked toolbar by clicking on it and dragging it downward.



Document Toolbar below the Program Toolbar

The Document Toolbar is a *Library* of symbols appropriate to a particular kind of diagram. It appears below the Program Toolbar (the "normal" toolbar) at the top of the SmartDraw Window.

Drag and Drop from Libraries

Drag shapes and objects from the library onto your page (by clicking and dragging with the mouse), just as you would from the Toolbar.

Adding Shapes to Libraries

You can add a shape or symbol (even one you created) to any SmartDraw Library. Open the library to which you want to add the shape. Then simply drag the shape from your page and drop it in the library.

If the shape is a new one that you created, you can use the *Join to Make a New Shape* command (**Lines** menu) to join your separate lines into a shape that SmartDraw recognizes as a single unit.

Creating New Libraries

To create a Library of your own, select *Create New Library* from the **Libraries** menu. You will be prompted for the name and location of your new library. If you want your library to appear alongside the others in the *Open Library* list, you must either place it in one of the existing library category folders, or create a new folder for it within the Libraries folder. (For more details, see *Libraries, New* in the SmartDraw **Help**.)

Add shapes to your new Library by dragging them from your page, or from other libraries. You can make a custom library of the shapes you use most often, and *Dock* it as a toolbar for your convenience.

[<< Previous Lesson](#) [Next Lesson >>](#)

Tutorial Lesson 11: Tables and Forms

You can create a *table* by clicking the Table Button  on the toolbar, or by selecting **Add New Table** from the **Tables** menu. Tables are particularly useful for creating timelines, organizational charts, software diagrams, and business forms.

Adding a new table presents the **Format Table Dialog**, where you define the properties of your new table:

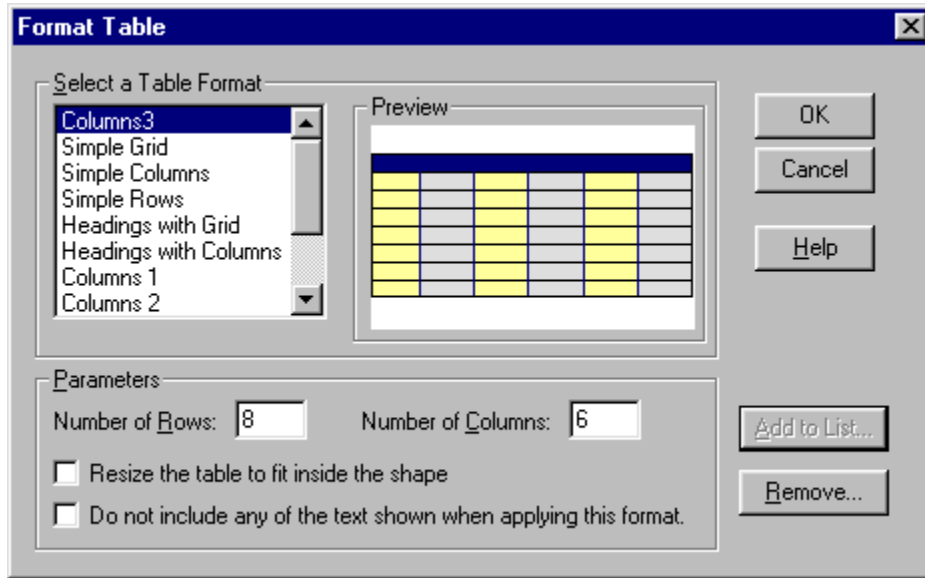

The Format Table Dialog

You can choose from among the ready-made table formats, or define your own by specifying the number of rows and columns. Click OK to add the new table to your drawing.

You can even insert tables inside shapes, to create multiple text-entry areas:



Different Shapes Containing the Same 2x4 Table

You can manipulate a table's rows, columns and cells in countless ways. You can join, split, or color the cells. You can drag the cell dividers to create wider or narrower rows and columns. You "lock" the text in certain cells so it can't be modified (very useful for creating the prompts in business forms.) SmartDraw can even *automatically* fill in the cells with numbers, dates, days of the week, months of the year, and other common data patterns, saving you the trouble of typing long series of data.

Some different table formats

You can even create business forms containing "live" data fields that can be filled-in on-screen:

WEEKLY TIME RECORD								
Employee's Name _____							Time Clock _____	
Department _____				Week Ending _____				
DAY	Morning		Afternoon		Overtime		Office Use	
	IN	OUT	IN	OUT	IN	OUT	Regular	Overtime
Monday								
Tuesday								
Wednesday								
Thursday								
Friday								
Saturday								
Sunday								
							Totals	
Approved by _____								

This entire business form consists of a single table

To learn more about the powerful features of SmartDraw's Tables, browse through the commands under the **Table** menu or see [Adding Tables to a Drawing](#).
 << [Previous Lesson](#) [Next Lesson](#) >>

Tutorial Lesson 12: The Professional Finish (Colors and Shadows)

SmartDraw provides dozens of pre-formatted *Styles* to give your drawings a polished, professional look. Choose *Colors and Shadows* from the **Edit** menu to see a list of styles you can choose from.

Selecting a style affects your entire drawing—each shape and line in the drawing is modified to match the selected Style. You can choose from different background colors, border and fill colors, shadows, and three-dimensional (raised and lowered) edge effects.

Here are just a few examples:

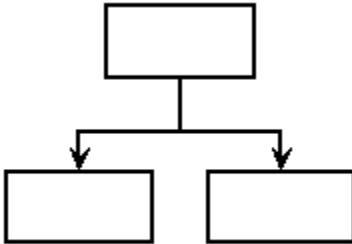

Basic Black & White

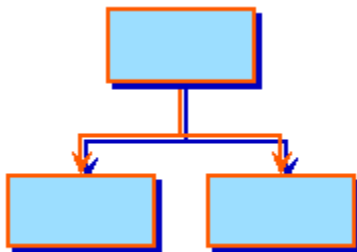

Color on White

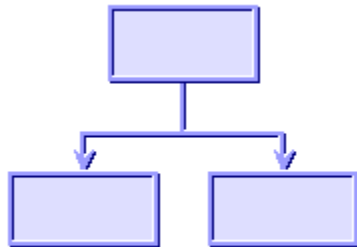

Pastel Raised

Enjoy SmartDraw

We hope this quick overview has helped you get started with SmartDraw. For complete information on SmartDraw's features, which go well beyond those described here, consult the rest of the on-line or printed SmartDraw User's Guide.

To order SmartDraw, call 1-800-501-0314, or visit the SmartDraw web site at <http://www.smartdraw.com>.

[<< Previous Lesson](#) [Back to the Beginning >>](#)

Adding Objects

A SmartDraw drawing is made up of shapes and lines. Shapes and lines are called **Objects**.

You add shapes and lines to your drawing using the bottom row of buttons on the program toolbar.

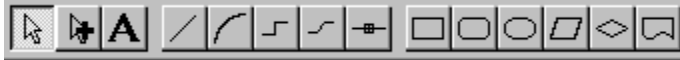

The Line and Shape Toolbar

There are two ways to add shapes and lines to your drawing:

Drag and Drop

This method requires only one mouse click and gives you a shape or line with a standard size and shape. This is best explained with an example.

To add a rectangle shape, first click on the rectangle button on the toolbar without letting go of the mouse button. While still holding down the mouse button, move the cursor onto your drawing. (This is called dragging with the mouse.) A rectangle shape follows the cursor. Once you let go of the mouse button, a new rectangle is added to your drawing.

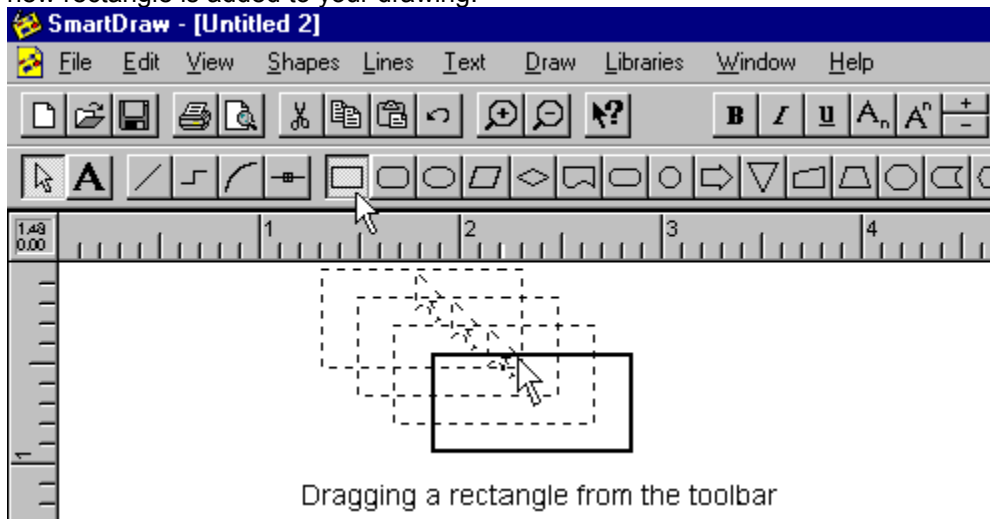

Drag and Drop

The size of the shapes you drag from the toolbar can be set by double clicking on the shape button.

Lines created by Drag and Drop are always the same size and shape. (Lines are usually drawn using the **Pencil** method instead, described below).

Symbols can also be dragged and dropped in the same way by clicking on the buttons in a library window.

Pencil Drawing



The pencil method requires two clicks but gives you full control over the size and shape of the object that you draw.

To add a rectangle shape using this method, first click on the rectangle button in the toolbar, and then let go of the mouse button. As the cursor is moved into the drawing window it changes to the pencil cursor.

Now if you click in the drawing window and keep the mouse button pressed and you move the mouse, a rectangle is drawn, as if the mouse were a pencil. This method can be used for shapes, lines and library symbols.

For shapes that can be stretched to any proportion, like rectangles, perfectly square versions can be made using the pencil draw method. To do this, simply hold down the **Ctrl key** while drawing the shape. This trick with the **Ctrl key** also applies when resizing a shape with the mouse.

Sticky Tool Selection

Normally, after you have drawn an object using the pencil method, the selection (pointer) tool is selected automatically. If you want to draw several copies of the same kind of object, you can force the drawing tool that you are using to remain selected by holding the **Shift key** down the first time you click on it. Holding the **Shift key** down when you select any drawing tool, causes it to remain selected until you click on another tool, or drag and drop a shape.

Drawing Lines and Curves

Lines and curves are usually drawn using the pencil method. There are four kinds of line: straight lines, arcs, segmented lines and curved lines.

Straight Lines

Straight lines connect any two points. They may be drawn at any angle, but will snap to perfectly horizontal or vertical directions if drawn close to these directions.

Lines may have one of three different shapes shown on the **Change Line Shape** menu.

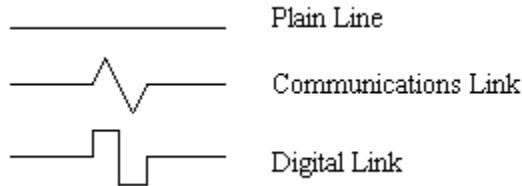

Line Types

A straight line is initially drawn as a plain line. You can change its shape by selecting it and applying the **Change Line Shape** command.

Arcs

Arcs connect any two points with the arc of a circle. Like straight lines, arcs can be rotated and converted to other line shapes using the **Change Line Shape** command. The degree of curvature of an arc can be adjusted using the special selection handle at its center.

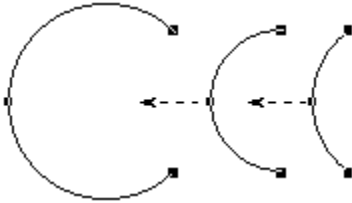

Adjusting the Curvature of an Arc

Segmented Lines

Segmented lines are designed to connect shapes. When linked to a shape (see [Linking Objects to Each Other](#)) the end linked becomes perpendicular to the side of the shape that it is linked to (i.e. it sticks out from the side). If the other end is linked to another shape, it also becomes perpendicular to the side of the shape that it is attached to.

Moving the shapes around causes the segmented line to change its shape to maintain the directions of its starting and ending segments. Segmented lines can have from 1 to 5 segments, depending on the arrangement of the shapes linked.

You can change the shape of segmented lines using the **Change Line Shape** menu. The **Flip** command ([Flipping Objects](#)) can also be used to create additional variations.

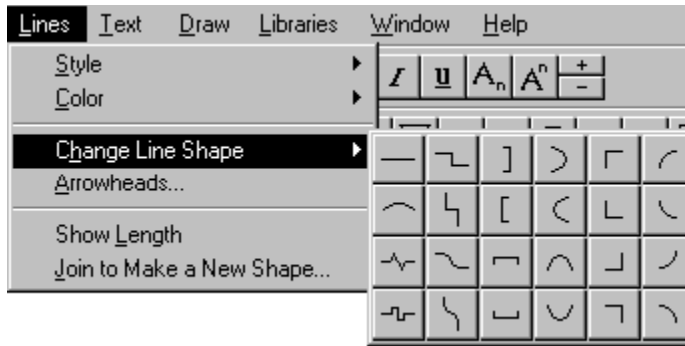

Change Line Shape

You can also change segmented lines into straight lines and curves using this command.

Curved Lines

Curved lines are the same as segmented lines with rounded corner. They too are designed primarily to link two shapes together. They follow the same rules as segmented lines, always maintaining a direction that sticks straight out from the side of the shape they are linked to.

When not linked, a curve is initially a simple "S". The **Change Line Shape** command can be used to change its shape to a semi-circle, an "S" curve, or any other line shape.

Automatic Connectors

An Automatic Connector is a special type of line that changes shape as other objects are linked to it. The best way to explain this is to consider an automatic connector designed to create the classic horizontal organization chart, as an example:

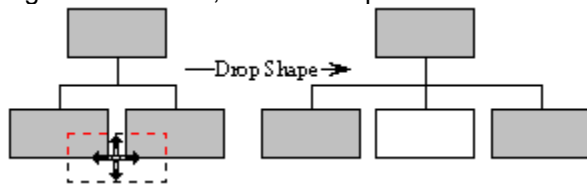

Adding a new shape to an automatic connector

As the figure shows, dropping a shape on an automatic connector automatically adds the shape to the group of shapes on the connector, with all necessary lines added automatically.

Connectors are described in their own chapter, [Using Automatic Connectors](#).

Connectors are either perfectly horizontal or vertical. The arrangement of the shapes attached to them can be changed using the **Change Connector Shape** command on the Lines menu. This replaces the **Change Line Shape** command when a connector is selected. Connectors cannot be changed into the other line types and vice-versa. The **Flip** command ([Flipping Objects](#)) can also be used to create additional variations.

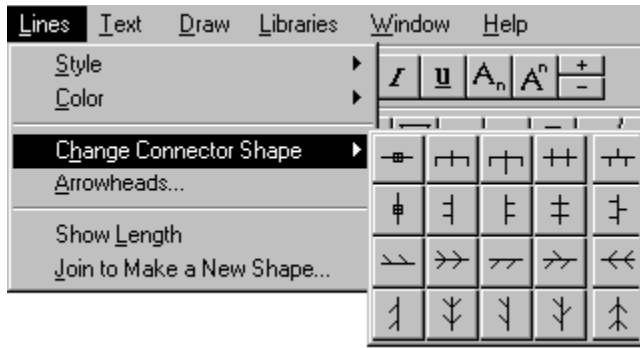

Change Connector Shape

Selecting Objects

Before any menu operations, such as color changes, can be applied to an object, it must first be selected.

Selected objects are shown with **Handles** on the corners and sides as shown below.

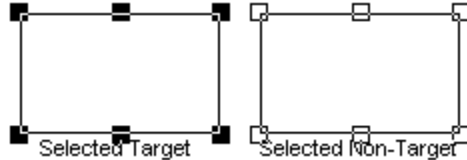

The most recently selected object is always shown with solid (black) handles and is called the **Target**. Other selected objects are shown with hollow handles. The target object is called the target because other selected objects are aligned or re-sized to match it when you use the **Align** and **Make Same Size** commands.

Objects that are linked to other objects have round handles at the connected points.



Objects are selected by clicking on them with the mouse while the Arrow button on the toolbar is depressed. Shapes filled with the transparent color must be clicked on their border.

Selecting an object by clicking on it, de-selects all other selected objects unless you hold the **Shift** or **Ctrl** key down while you click. With the **Shift** or **Ctrl** key held down, clicking on a selected object de-selects it.

Selecting Multiple Objects



The easiest way to select more than one object is to first click on the **Multiple Selection** tool on the toolbar. With this tool selected, clicking on an object does not de-select others. You can select more than one object by simply clicking on them one at a time. Clicking in the background of the drawing cancels the selection of the **Multiple Selection** tool.

You can also select more than one object by dragging the mouse with the Arrow button depressed. To drag the mouse, hold the left mouse button down and move the mouse. Then let the mouse button up.

Dragging the mouse this way across the drawing window draws a temporary dotted rectangle. Any objects completely enclosed by this rectangle are selected once the mouse button is released. Holding the **Shift** key down while dragging adds the enclosed objects to any existing selection.

Sometimes, it's hard to click on the object that you want because other objects lie on top (or in front) of it. There are two ways to overcome this:

You can select the objects on top and use the **Send to the Back** command under the Arrange menu.

You can also drag around all the objects, selecting them all. Shift clicking on the objects in the front now de-selects them, leaving only the object you want still selected.

To select all the objects in a drawing use the **Select All** command under the Edit menu.

Once selected, the colors, borders and other attributes of objects can be changed using the menu commands. Selected objects can also be cut, copied and duplicated. Typing from the keyboard when a shape is selected adds text to it. These actions are described in much greater detail later.

Moving Objects

Using the Mouse

You can move an object simply by clicking on it with the mouse, and then moving the mouse, while keeping the mouse button pressed down. An outline of the object follows the mouse as you move it.

If you hold the **Shift key** down while you use the mouse to move an object, it moves only horizontally or vertically (not diagonally).

Moving a Group of Objects

If more than one object is selected, clicking on one of them moves all of the selected objects as a group. More than one object may also be moved if the object clicked on is linked to others. When a group of objects is moved, an outline of the rectangle that encloses the group follows the mouse.

Using the Arrow Keys

You can use the arrow keys to move a selected object very precisely. Typing an arrow key moves the object by one screen pixel (1/100 of an inch at normal viewing magnification) with each keystroke. The right and down arrows move the object to the right and bottom. The left and up arrows move it to the left and up. If more than one object is selected, all are moved.

Aligning Objects

The **Align** command under the Arrange menu can be used to align all selected objects with the selected target object. This is described in detail in the *Arranging Objects* section [Aligning Objects](#).

Spacing Objects Evenly

The **Space Evenly** command under the Arrange menu can be used to arrange all selected objects so that they are separated by equal distances. This is described in detail in the *Arranging Objects* section [Spacing Objects Evenly](#).

Centering the Drawing on the Page

The **Center Drawing on Page** command under the Arrange menu can be used to move all the objects in the drawing so that they are centered in the minimum number of pages needed to print them. This is described in detail in the *Arranging Objects* section [Centering the Drawing on the Page](#).

Sizing Objects

Using the Mouse

To change the size and shape of an object you must first select it, and then click on one of the selection handles (or black squares) with the mouse. Moving the mouse, while keeping the mouse button pressed down, moves the handle and changes the size of the object.

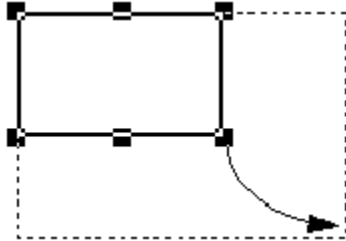

Growing an Object

Only one object at a time can be resized this way.

Some shapes, like rectangles, can be sized to any proportion. Others, like circles, can grow so as to maintain their proportions.

Handles drawn in the middle of the sides of the rectangle grow the object only in the direction perpendicular to that side. Handles at the corners grow in all directions for non-proportional shapes.

Proportional shapes (like circles) have no handles on their sides, and their corner handles grow the shape only proportionately.

For shapes that can be stretched to any proportion, like rectangles, perfectly square versions can be made by holding down the **Ctrl Key** while dragging with the mouse.

Holding down the **Shift Key** forces them to grow in proportion to their current shape.

For shapes that can normally only be sized proportionately, holding down the **Shift Key** while dragging with the mouse allows them to be sized to any proportion.

Sizing with the Arrow Keys

You can finely adjust the size of a selected object using the arrow keys. Typing an arrow key, while holding down the **Shift Key**, increases or decreases the size of the object by one screen pixel (1/100 of an inch at normal viewing magnification) with each keystroke. The right and down arrows increase the size at the right and bottom. The left and up arrows decrease the size at the right and bottom.

You can apply these changes to more than one object simultaneously, by selecting more than one first.

Make Same Size

The **Make Same Size** command under the Arrange menu can be used to make all selected objects the same size as the selected target object. This is described in detail in the *Arranging Objects* section [Making Objects the Same Size](#).

Grouping

Objects may be combined into **Groups**. When grouped they may be sized proportionately as a single object. This is described in detail in the *Creating Your Own Shapes* section [Grouping and Ungrouping](#).

The Shape Sizing Dialog

The **Shape Sizing Dialog** allows you to change the sizing behavior of shape.

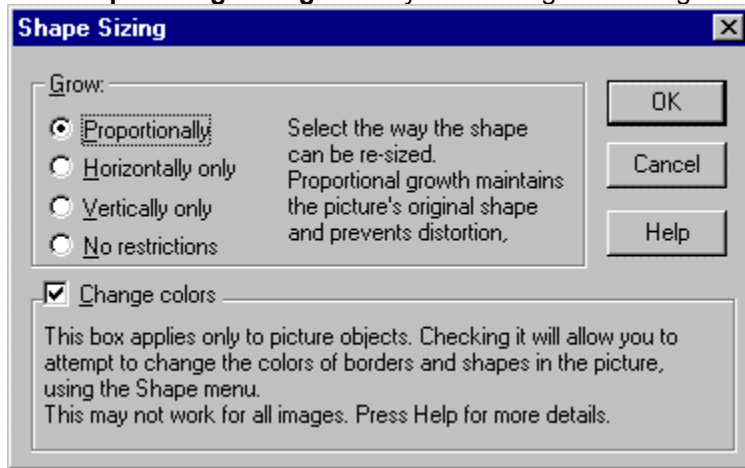

Shape Sizing Dialog

There are four choices of sizing behavior:

Proportional objects have only four grow handles (one at each corner) and maintain their proportions when re-sized. Imported images (and many library symbols) are initially set to resize proportionally.

Horizontal Only objects have only two grow handles and can be re-sized only in the horizontal direction.

Vertical Only objects have only two grow handles and can be re-sized only in the vertical direction. This is good for objects that represent vertical lines.

No restrictions allows objects to grow in all directions without maintaining proportions. These objects have the usual 8 grow handles.

The **Change Colors** box applies only to certain library symbols and imported images and is described in [Image Objects](#).

The Position and Size Dialog

You can set the size and position of an object to an exact value using the **Position and Size Dialog**. This allows you enter dimensions and position for a single object in the same coordinate system shown on the rulers ([Setting the Ruler Scale](#)). You show the dialog by first selecting an object and then using the **Position and Size** command under the Arrange menu.

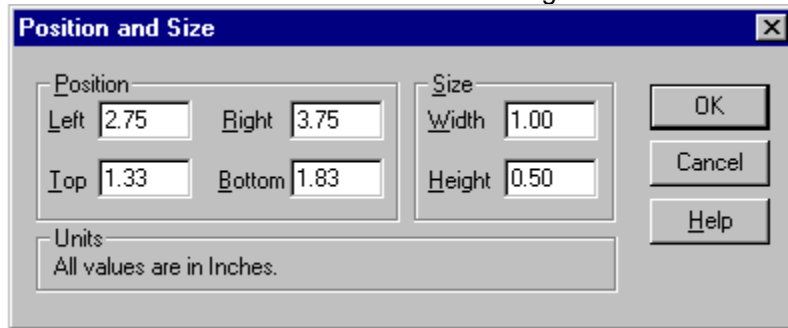

The Position and Size Dialog

You can specify the left, top right and bottom of the shape in the units shown.

Changing the left and top values also changes the right and bottom, shifting them to maintain the same width and height.

Changing the right and bottom values however, leaves the left and top unchanged, but adjusts the width and height, and vice versa.

Rotating Objects

All shapes, text and straight lines can be **Rotated** by any angle. You can do this manually by selecting the rotation handle that these objects show when selected. The cursor changes to the "rotation" shape shown in the margin when positioned over a rotation handle.

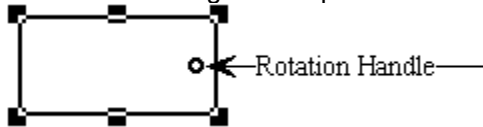

A Rotation Handle

Clicking on the rotation handle and dragging with mouse rotates the shape about its center.

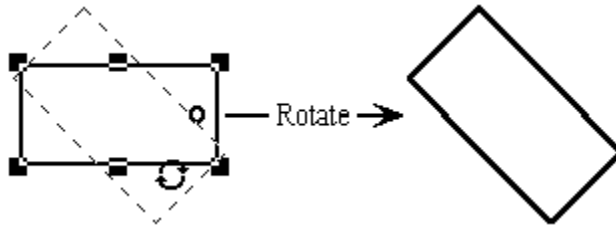

Rotating a Shape

When the **Snap to Grid** feature is turned on, the angle of rotation snaps to an increment of 15 degrees (15, 30, 45 and so on..).

You can also rotate objects using the **Rotate** commands on the Arrange menu. The **Rotate** sub-menu provides commands to rotate objects by 90 degrees in either direction, and to return an object to the horizontal position.

The **Set Angle** command allows you to specify the exact angle of rotation within one tenth of a degree, via the **Set Rotation Angle Dialog**.

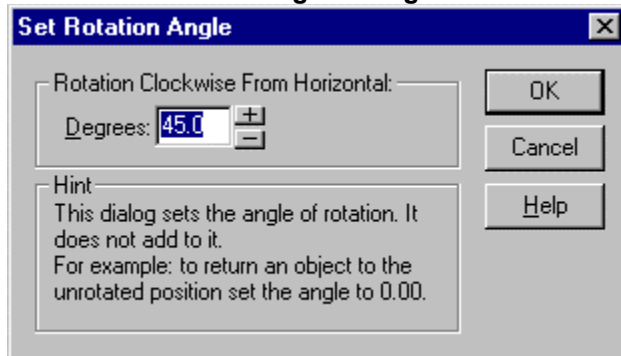

Set Rotation Angle Dialog

The rotation commands on the menu apply to all selected objects. This allows you to rotate a group of objects by the same angle. Furthermore, the angle shown in the Set Rotation Angle dialog is the one associated with the last object selected (the **target object**, described in [Selecting Objects](#)).

This feature allows you to align the rotation angle of a group of objects to one particular object: Simply select the objects that you wish to align, then, holding the **Shift key** down, select the target object that you wish to align them to. Now select the **Set Angle** command and press **OK**.

You can rotate straight lines, any shape, and most imported images. Segmented lines, curves, bitmapped image objects, and automatic connectors do not rotate. Also, objects linked to others do not rotate. (since they cannot maintain their link if they do!) However, you can rotate a shape or line before you link it.

Objects that do not rotate do not show a rotation handle.

When an object is rotated, the text associated with it rotates too.

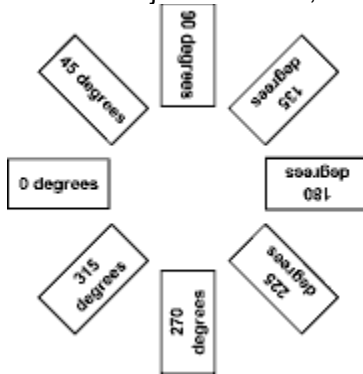

Rotated Shapes with Text

If you want the text in a rotated object to remain horizontal, you can change it into a new (rotated) shape, before you add text. This is described in [Joining Lines to Make a New Shape](#).

Flipping Objects

All objects, except bitmapped images, can be **Flipped**, either horizontally or vertically. Horizontal flipping changes an object as if it were reflected in a mirror **down** its middle.

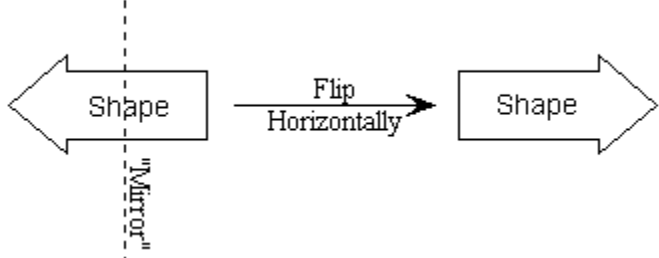

Horizontal Flipping

Vertical flipping changes an object as if it were reflected in a mirror **across** its middle.

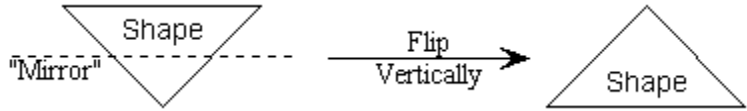

Vertical Flipping

Note that text is unaffected by flipping.

Flipping can be used to generate even more styles of connectors and segmented lines than are available on the **Change Connector Shape** and **Change Line Shape** menus.



Changing Connector Styles with the Flip Command

Deleting Objects

You can delete objects from a drawing by simply selecting them and then typing either the **Del key**, or the **Backspace**. The **Clear** command under the Edit menu has exactly the same effect.

Duplicating Objects

The **Duplicate** command, under the Edit menu, makes a copy of the selected objects and adds them to the drawing, offset by a small distance from the original objects.

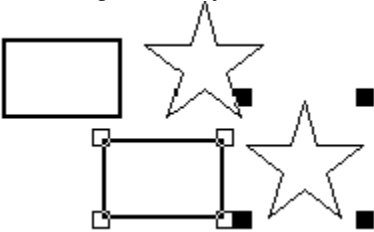

Duplicating Two Objects

The duplicated objects are automatically selected so that they can be moved as a group by clicking on one of them. If the newly duplicated objects are moved with respect to their original copies, the new distance between them and the original set is used as the offset for further duplications. You can use this feature to create rows and columns of evenly spaced lines or shapes very easily.

The illustration below shows the steps involved in making a column of evenly spaced lines.

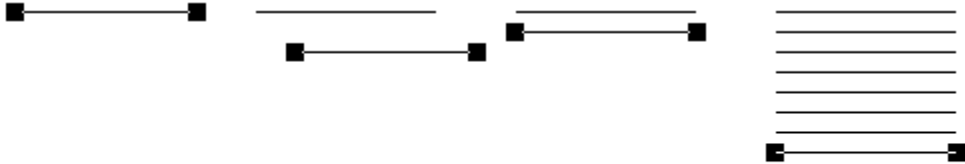

Step 1 - Draw a line

Step 2 - Duplicate it

Step 3 - Adjust the offset

Step 4 - Duplicate again and again

Changing the Appearance of Shapes

The Shapes menu can be used to change the color and border style of existing shape objects.

The first step is to select the shape or shapes you wish to change, by clicking on them. (See [Selecting Objects](#).) Selecting a color from the **Fill Color** menu will change the fill color of any selected shape. This color will also be the fill color of any new shape added to the drawing afterward. Lines, Image objects and symbols that are not re-colorable (See [Changing the Settings for a Symbol](#)) are not affected by fill color.



The Color Menu

The fill color can be transparent, which means that the background of the drawing shows through the shape.

You can also pick from any of the 16 million colors supported by Windows using the [More Colors](#) selection.

Shapes have a border around their edge. This can be dotted, dashed, or solid with several weights. Heavy borders always grow towards the center of the shape.

Symbols that can be re-colored respond to border style changes by changing their appearance. Those that do not, show a border around the rectangle that encloses the drawing.

Shapes may also have no border (**None**). These shapes must have a different fill color than the background or they will not be visible.

The **Border Color** and **Border Style** menus change the appearance of selected shape borders. The values selected also become the default settings for the border of any new shape added to the drawing.

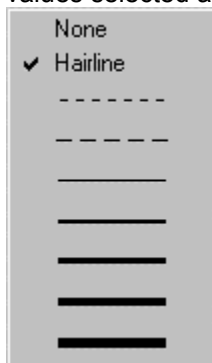

Border Style Menu

The **Shading** menu is used to fill a shape with a hatched pattern. The menu shows five hatched patterns and a plain (no hatching) choice.

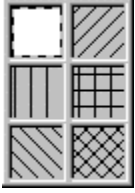

The Shading Menu

The hatched patterns use the border color for the hatching on a background determined by the fill color (including transparent fills). If a hatched pattern is selected and the border and background colors are the same, the border color is changed to a contrasting color.

Changing the Shape

The shape of an existing shape object can be changed to any of the other 24 standard SmartDraw shapes, using the **Shape** command under the Shapes menu. This displays the Change Shape menu.



Change Shape Menu

Any selected shapes are converted to the shape chosen from this menu. The command has no effect on library symbols or images.

Adjusting Shape Outlines

The outline of many of the standard toolbar shapes can be adjusted (for example, the degree of roundness of rounded rectangles or the angle between the vertical and horizontal sides of a parallelogram). The defaults for these quantities can be set when editing the toolbar. (See [Changing the Program Toolbar](#).)

You can adjust the outlines of objects already in the drawing by clicking on their **Adjustment Handles**.

Adjustment Handle

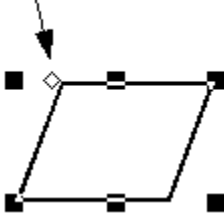

Adjusting Shapes

To adjust the outline of an adjustable shape, click and drag on the open diamond-shaped handle that appears when an adjustable shape is selected. You can see the effect of the changes you are making in real time as a temporary dotted image shows the new outline of the shape. Release the mouse and the shape changes its outline to match the dotted image.

Redesigning Shape Outlines

Shapes can also be completely decomposed into their component lines and curves using the **Edit Shape Outline** command. . You can use this feature to redesign the outline of a shape, and then join the outline back into a new shape using the **Join to Make a New Shape** command under the Line menu. This is described in more detail in [Joining Lines to Make a New Shape](#).

Changing the Appearance of Lines

The Lines menu can be used to change the color and thickness of selected straight lines, arcs, segmented lines, curved lines and connectors.

The **Line Style** command changes the style. This can be dotted, dashed, or solid with several weights.

The **Line Color** command changes the color of any selected lines.

Arrowheads

You may add arrowheads to either or both ends of any line. There are 35 different built-in arrowhead styles, and you can also create your own. The style, size and placement on the line may be set using the **Arrowhead Dialog**. This is presented via the **Arrowheads...** command under the Lines menu.

Arrowhead Dialog

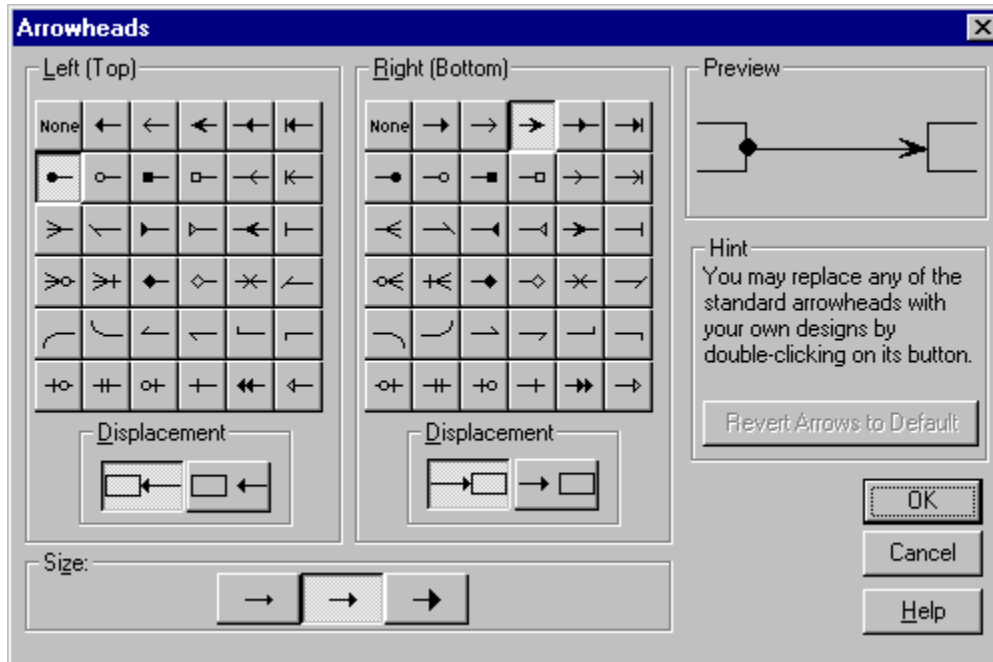

The Arrowheads Dialog

The buttons lets you pick an arrowhead style for each end of the line:

Left (Top)

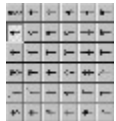

Clicking on one of the 36 style buttons changes the type of arrowhead that will appear on the left end (or top end if vertical) of the lines currently selected. A preview of the effect of this selection on a horizontal line is shown in the preview window. The "None" selection results in no arrowhead at the left end.

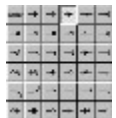

Right (Bottom)

Clicking on these buttons changes the style of the right end (or bottom end if vertical) of the lines currently selected.

Displacement



This property controls whether the end of a line with an arrowhead is drawn to its full length or a little short. This is useful when lines are linked to shapes. If the line is displaced, it does not appear to touch

the shape but still remains linked to it. This property can be controlled independently for each end of a line, and does not apply to ends with no arrowhead.

Size



Clicking on one of these three buttons controls the size of the arrows and applies to both ends of the line.

Arrowheads in the Center of Lines

Three of the arrowhead styles place an arrowhead at the center of the line instead of at the end.

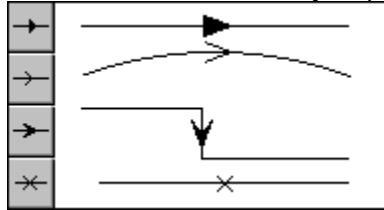

Centered Arrowheads

Lines with different settings

If the Arrowhead dialog shows no setting for a property, then the lines currently selected have different values for this property. For example, if two lines have different right arrows, no right-arrow buttons will appear to be pushed in when the dialog is displayed. If you leave the style buttons un-pushed, but you push one of the size buttons, then, when you press the OK button, both arrowheads will change size but they will retain their different right arrow styles.

Once assigned, an arrowhead remains fixed on the end to which it was assigned, despite any later changes in the line's direction.

Creating Your Own Arrowheads

If you double-click on any of the 35 right-facing arrow style buttons you can change its style to one of your own design.

See [Creating Your Own Arrowheads](#)

Creating Your Own Arrowheads

In addition to the 35 built-in arrowhead styles, you can create your own. There are four steps involved:

1. Create an image for your arrowhead

Begin by drawing the symbol you want to use as an arrowhead, either with SmartDraw, or with some other drawing program. You can draw the symbol at a comfortable size. It need not be as small as the eventual arrowhead. SmartDraw will eventually scale it to the right size.

The arrowhead design should be for a *right-facing* horizontal arrow. SmartDraw will handle transforming the image for other directions. The arrowhead will eventually be drawn with dimensions that are 1.75x longer than wide. For best results, draw your symbol with that ratio of length to width.



New Arrowhead Image

2. Copy it to the clipboard

Use the **Copy** command to transfer your image to the clipboard ([Copying and Pasting](#)).

3. Open the arrowhead dialog

Select a line and use the **Arrowheads** command under the Lines menu to open the arrowhead dialog.

4. Double-click on a right-facing button.

You may replace any of the standard arrowheads with your custom design. Select the arrowhead you want to replace and double-click on its right facing button. (When you replace an arrowhead on the right-facing button you automatically replace it for the left-facing button also.) You are presented with the **Customize Arrowhead Dialog**.

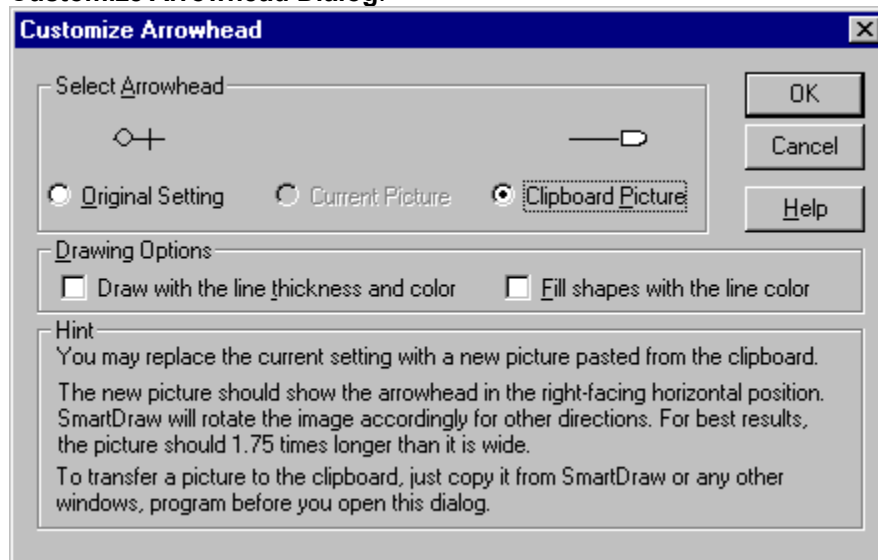

Customize Arrowhead Dialog

You should see your design attached to the end of a line above the **Clipboard Picture** radio button. Selecting this radio button replaces the built-in arrowhead with your image. You can also use this dialog to return to the standard arrowheads at any time.

There are two other choices you can make with this dialog: To draw the outline of the custom arrowhead with the same thickness and color as the line it is attached to, and to fill any shapes in the design with the

same color as the line.

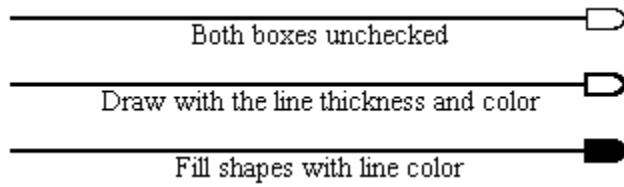

Effect of Custom Arrowhead Dialog checkboxes

The effects of these choices are shown above.

Once you have assigned a custom arrowhead to a button in the arrowhead dialog, you may assign it to any line in the normal way. The arrowhead is stored in your SmartDraw preferences (smartd4.opt) in your Windows directory. You can revert all of your arrowhead settings back to their default using the **Revert Arrows to Default** button in the arrowhead dialog

Changing Line Shape

Lines and Automatic Connectors can have many different shapes, and you can convert one line shape into another using the **Change Line Shape** and **Change Connector Shape** commands. Note that you cannot change a line into an Automatic Connector, and vice-versa. These commands are described in [Drawing Lines and Curves](#).

Changing the Background Color

The background of the drawing itself may be colored. You change the background color using the **Background Color** command under the View menu. One of the selections is transparent. Drawings with this colored background differ from those with white backgrounds only in the way their images are exported. Drawings with transparent backgrounds export transparent images that acquire the background color of the document that displays them. Drawings with white backgrounds export images that have opaque white backgrounds, no matter where they are displayed.

The background color is one of the settings specified in the Color and Shadow style.

Colors and Shadows

The **Colors and Shadows** command, under the Edit menu, allows you to apply a design **Style** to your drawing. A style is a color scheme, specifying the color of the drawing background, shapes, borders, lines, text and shadows, and a shadow type. Using the command presents the **Colors and Shadow Dialog**.

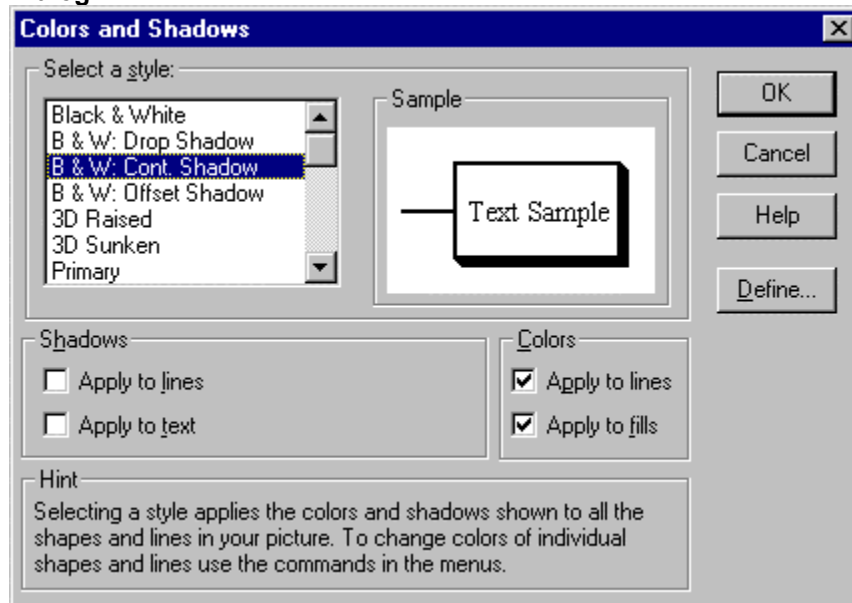

The Colors and Shadows Dialog

SmartDraw provides many ready-made styles. These are listed in the **Select a style** list box. A preview of the style's appearance is shown in the **Sample** window to the right of it. Changing the style selection changes the preview. You can browse through the available styles using the up and down arrow keys to change the selection.

Once you have selected the style you want, pressing the OK button applies the colors and shadow styles to your drawing. This is a very quick and easy way to change all the colors in a drawing to a consistent style in one operation. You can undo any change you make, or you can apply another style to try any number of different "looks".

If you select a shadowed style, shadows are applied to your shapes. Some styles also apply the same kind of shadow to lines and to text. The 3D styles give the raised and sunken looks common in Windows dialogs.

You can control whether a shadowed style applies the shadows to lines and text by checking the boxes in the shadow section of the dialog:

Apply To Lines

Checking this box applies the selected shadow style to lines as well as shapes. This is only visible if a shadow style is selected, and is forced to be on for the raised and sunken shadow styles.

Apply to Text

Checking this box applies the shadow style to text as well as shapes. This is only visible if a shadow style is selected. Text does not look good shadowed unless it has a point size of 18 or greater.

Reverse Text Shadow

This option is only available if the raised or sunken 3D shadow styles are chosen. Checking this box applies the reverse text shadow: raised if the shape shadow is sunken, sunken if the shape shadow is raised. This can give an interesting effect.

Controlling Color Changes

You can also control whether color changes are applied by checking the boxes in the Colors section of the dialog. If the **Lines** box is checked, changes are applied to both borders and lines. This is forced to be on for 3D shadowed styles. If the **Fills** box is checked, then color changes are applied to both text and fill colors.

See also:

[Overriding Shadows](#)

[Defining Your Own Styles](#)

[Overriding Styles](#)

Overriding Shadows

SmartDraw allows you to override the shadow styles for individual shapes, lines and text blocks.

Shape and Line Shadow

You can use the **Hide Shadow** command, under the Arrange menu, to turn off any shadows for shapes or lines that are currently selected. If any of the shapes or lines selected already have hidden shadows, the menu item changes to **Show Shadow**, and selecting it turns the shadows back on for these objects.

Show Shadow has no effect on selected lines if the current style does not normally apply shadows to lines.

Usually it is not a good idea to remove shadows when using the three dimensional sunken or raised styles, since borders and lines are the same color as the background and will look as if they have disappeared if their shadows are removed.

Text Shadow

The **Shadow** command, under the Text menu, has an effect on text shadows similar to the effect **Hide** and **Show Shadow** have on the shadows of lines and shapes. Selecting this command toggles text shadows on and off for selected objects. Its status is shown by a check mark. This command has no effect if the current style does not specify text shadows. Again, it is not a good idea to remove the shadows of sunken or raised text.

Defining Your Own Styles

Pressing the **Define** button in the **Colors and Shadows** dialog allows you to add your own styles, or to modify the standard ones, by presenting the **Define Colors and Shadow Styles Dialog**.

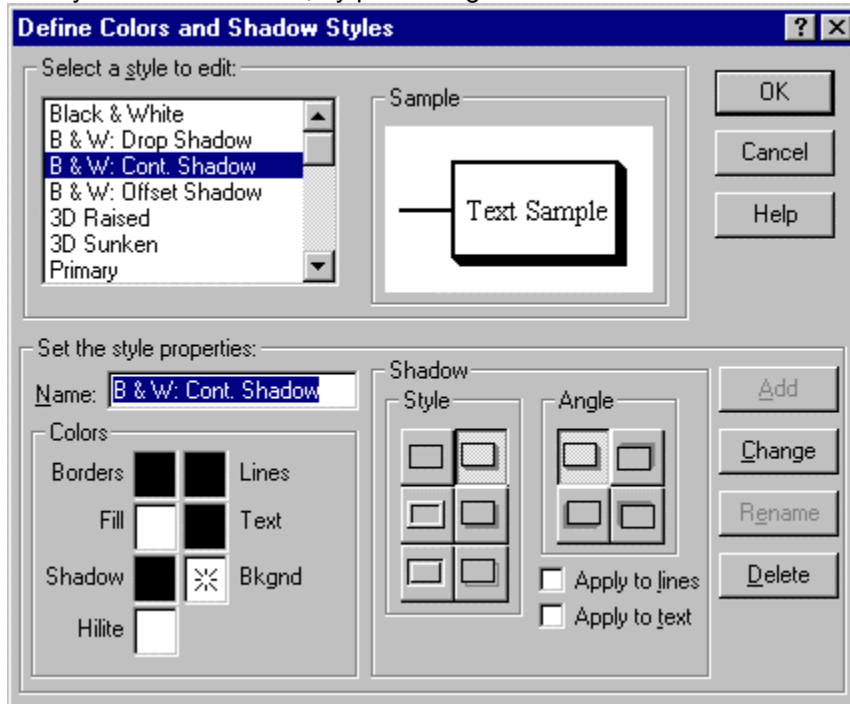

The Define Colors and Shadow Styles Dialog

Selecting a Style to Edit

Selecting an item in the scrolling list selects the style to be edited. The style's name is copied into the **Name** field, and the **Change** button becomes active. Changing the style selected in the list cancels any changes made to the previously selected style.

The **Sample** window shows a preview of the current style as the selection in the list is changed, and as the settings for the selected style are changed.

Changing Style Settings



The style settings are controlled by the color and shadow controls. Seven color panels are displayed showing the current color scheme. Pressing on any color panel with the mouse displays the color menu. The menu changes the color selection.

The selection on the color menu shown with a dotted border represents the **Transparent** color.

The **Border** color sets the color of shape borders. **Line** color sets the color of lines, segmented lines and curved lines. **Fill** Color sets the color of the inside of shapes. This can be transparent. **Text** color sets the

color of text. **Shadow** color sets the color of any shadows. **Highlight** color is only used by the raised and sunken three-dimensional shadow styles.

Background color sets the color of the drawing background. This, too, can be transparent.



There are six shadow styles to choose from. These are shown in the array of shadow buttons, with the top left button representing no shadow. If a shadow style in the right column is selected the angle of the shadow can also be controlled using the controls labeled **Angle**.



The four angle buttons show the current angle for the shadow. Pressing one changes the selection to the angle shown on its face. These controls are only visible if one of the shadow styles in the right column of the shadow control is selected.

Shadows can be applied optionally to lines and text. Check boxes control these selections.

Adding a Style

You can add a new style by pressing the **Add** button. This button becomes active when you change the **Name** field so that it no longer matches the style selected in the list, **and** the settings for colors and shadow have been changed. Pressing it adds the current color and shadow settings as a new style with the name you choose.

Changing a Style

You can change the currently selected style by pressing the **Change** button. This button is active when the name in the **Name** field matches the style selected in the list **and** the settings for colors and shadow have been changed. Pressing it changes the selected style to the current color and shadow settings.

Renaming a Style

The **Rename** button becomes active when the name of the selected style has been changed, but the parameters have not. Pressing it renames the current style.

Deleting a Style

The **Delete** button is active when the name in the **Name** field matches the style selected in the list. Pressing it removes the selected style from the list.

Overriding Styles

All new shapes and lines added to your drawing adopt the color scheme and shadow style of the current style.

You can change the colors of any object, after it has been created, using commands on the Shapes and Lines menus. This changes the color scheme of the current style, and any new objects added adopt the new scheme. Existing objects that are not selected when a color is changed are unaffected.

You cannot change the shadow style of individual objects. Every object follows the shadow scheme of the current style. To change the appearance of shadows, you must select another style, or modify the current style's shadow scheme.

There are two ways to add text to your drawing: inside a shape or as a *background text* object.

Entering Text in Shapes

You can enter text inside the 24 standard SmartDraw shapes displayed on the toolbar, and inside most library symbols.



A shape can be opened for text entry by simply selecting it and starting to type. Shapes can also be opened for text entry by double clicking on them, or by pressing the text button on the toolbar and clicking once on the shape.

When a shape (or background text object) is opened for text entry, the standard Windows insertion point appears. This is a flashing vertical line. All of the normal Windows text editing conventions apply: Dragging with the mouse selects text (shown as inverted). Selected text can be cut, deleted or copied. The font, size, style and color of selected text can be changed using commands on the Text menu.

See also:

[Automatic Text Resizing](#)

[Text Entry Properties](#)

[Entering Background Text](#)

[Changing Fonts, Size and Style](#)

[Changing Text Using the Toolbar](#)

[Positioning Text Inside Shapes](#)

[Inserting Symbols](#)

[Bulleted Text](#)

[Changing Text Color](#)

Automatic Text Resizing

As you add text to a shape it word-wraps like a word processor until the shape is full. Then, as you enter more text, the size of the text shrinks automatically to allow more to fit inside the shape. Finally, when the text has shrunk to a minimum size, the shape grows to accommodate more text. This is shown below.

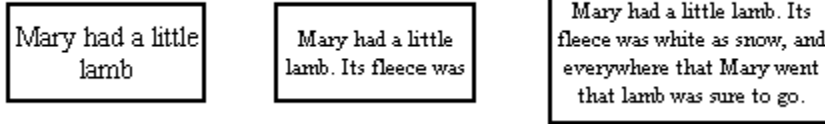

The text shrinks, and then the box grows, as you add more text.

The way a shape grows to accommodate more text is determined by both the alignment of the text in the shape, and the sizing rules chosen using the **Text Entry Properties Dialog**.

Text Entry Properties

The **Text Entry Properties Dialog** is displayed using the command of the same name under the Shapes menu. Changes made with this dialog apply to any selected shape (including a shape that contains a table).

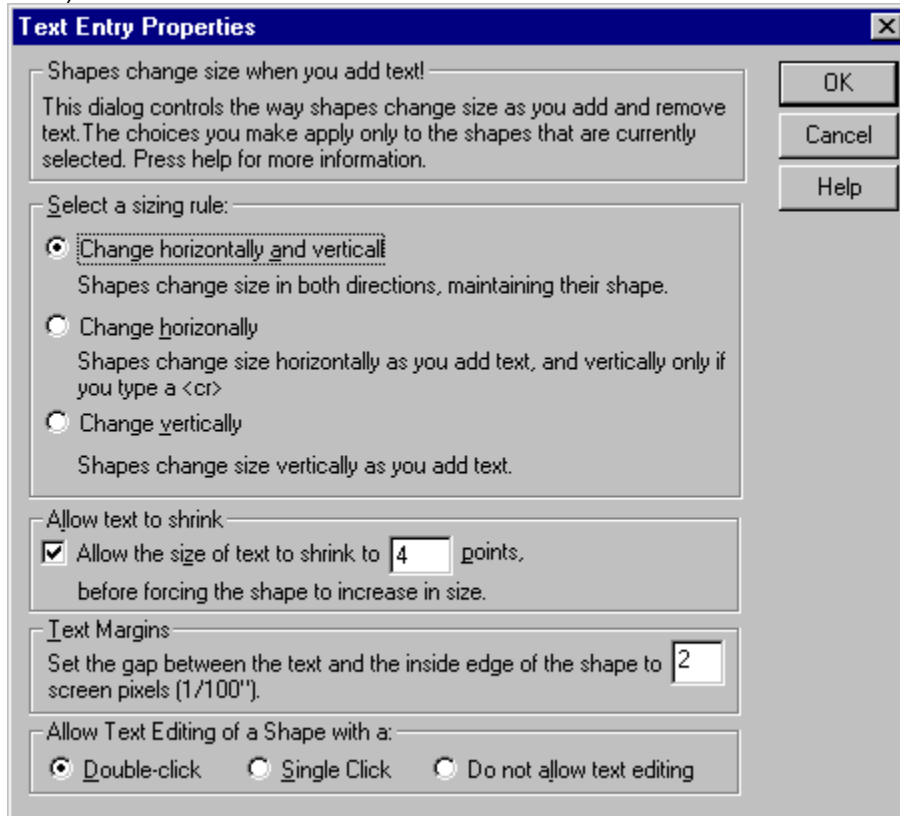

Text Entry Properties Dialog

This dialog allows you to set:

- The way shapes grow as you add text
- The gap between the edge of the shape and the text it contains
- How to begin text entry by clicking with the mouse.

Text Sizing Rules

There are three different ways shapes can grow as you add text.

Horizontally and Vertically

This is the default for most shapes. The shape grows so as to maintain its proportions.

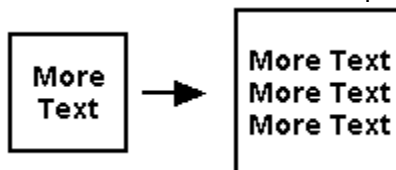

Horizontal and Vertical Text Sizing

Horizontally

This is the default for background text objects and the text that appears below or above image objects

and symbols. New text is added on the current line. New lines occur only when the **Enter Key** is typed.



Horizontal Text Sizing

Vertically

Text "wraps" within the width of the shape, like a word processor does when the text reaches edge the of the page. The shape grows vertically as new lines are added.

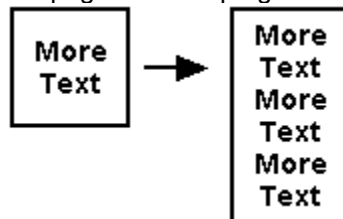

Vertical Text Sizing

Effect of Text Alignment

As a shape grows according to these rules, it maintains a fixed point according to its text alignment. If text inside a shape is centered, the center of the shape remains fixed and the shape grows outward from the center. A shape with left-aligned text remains fixed at its left edge and grows on the right. Shapes with top-justified text grow downward, and so on.

Allowing Text to Shrink

You can force the text inside a shape to attempt to shrink before it causes the shape to grow by checking the **Allow Text to Shrink** checkbox. You can also specify the minimum size that the text will shrink to before it forces the shape to grow.

Text Margins

The gap between the edge of the text inside a shape and the inside of the shape border is set using the Text Margins control. This setting is in 1/100 of an inch and defaults to 2. Reducing this value will allow more text to fit inside a shape.

Text Entry and Mouse Clicks

The three **Allow Text Editing with a...** choices allow you to set whether a single-click or a double-click on a shape opens it for text editing, or whether it can be opened for text editing at all!

Normal shapes require a double-click for text editing. (A single click is used to move and select them.) Shapes that contain tables, on the other hand, normally require only a single click to begin editing.

Sometimes it is useful to require a single click for editing normal shapes. A good example of this is using SmartDraw to fill-in a form. Equally, if you have created a multiple-text-entry-area flow-charting symbol, you will probably want it to require a double-click for text editing like normal shapes.

The **Do not allow text editing** choice is also useful for forms. It prevents the labels and prompts in the form from being changed while filling-in the form.

Defaults

All of the settings in the **Text Entry Properties** dialog become the defaults for newly created objects once

applied to a selected object, with the important exception of the mouse-clicks setting.

Entering Background Text



If the text button on the toolbar is pressed, then clicking in the background of the drawing starts a text entry session. Any text entered forms a new object called a **Background Text Object**. This is a *rectangle* shape that initially has no border, and has a transparent fill.

You can select background text objects and open them for further text entry like any other shape. You may assign them a border and colors and rotate them, like any other shape. However, they do have some properties that differ from a normal shape.

Text objects align to the **Snaps** according the baseline of the first line of text, not their center or top-left corner like other shapes. Also, they are removed from the drawing if all their text contents are deleted, so that your drawing does not become cluttered with invisible empty shapes.

Attaching Text to Lines

In addition to adding text to shapes, you can also label lines with text. To do this, simply select a line and begin typing. A background text object will be created and attached to the line, normally in the center.

This text object will remain attached to line when you move it. It can change its orientation to match that of the line, or it can remain horizontal. You control this using the **Align Text on the Line** command settings, found on the **Lines Menu**. There are two choices: **Along the Direction of the Line**, and **Horizontally**.

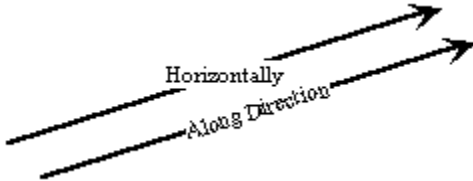

Text attached to a line

The text is positioned on the line according to the current text alignment setting for the *line* (not the text object attached to it). You can change this by selecting the *line* and using the **Alignment** command on the Text menu.

When the text is added on top of the line, the text is automatically given an opaque background that hides the line underneath. When text is added below or above the line, the text is given a transparent background so that the line shows through.

You can show the line through the text (or vice versa) by selecting the *text object* itself and changing its fill color to transparent, using the Shape menu.

The text entry position for an imported image or a library symbol can be set so that text goes above or below it and not inside. These shapes behave similarly to lines with respect to entering text. Selecting the shape and starting to type creates a background text object that remains linked to the shape.

Dimensioning: Showing Line Length

You can set lines to show their length in the same units as currently displayed on the rulers (see [Setting the Ruler Scale](#)) using the **Show Length** command under the Lines menu. This causes any lines that are selected to display their current length as an attached text object, or **Length Label**.

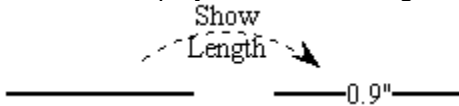

Show Length Command

The length label changes its value as the length of the line is adjusted. Changing the ruler scale, or its units, using the **Define Rulers and Grid** dialog also changes the value of the line length label.

A length label is removed from a line by clicking on the label itself and deleting it.

If you want to use your own units or descriptions, you can attach your own text to any length label simply by typing it in. Text that is not part of the length value is preserved as the line changes length:

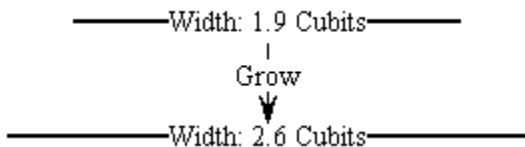

User-defined Text in a Length Label

Length labels are used to create *automatic dimension lines*. There are arrowhead styles that can be placed at each end of line to complete the appearance. Segmented and curved lines can also show their length. For segmented lines, the length is the distance between the ends in the direction of the text label:

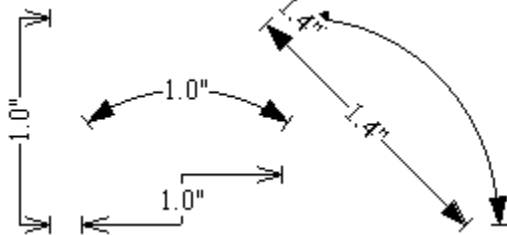

Length Labels

Changing Fonts, Size and Style

You can change the font, size and style of text using the **Font** command under the Text menu. This presents the standard **Font Dialog**.

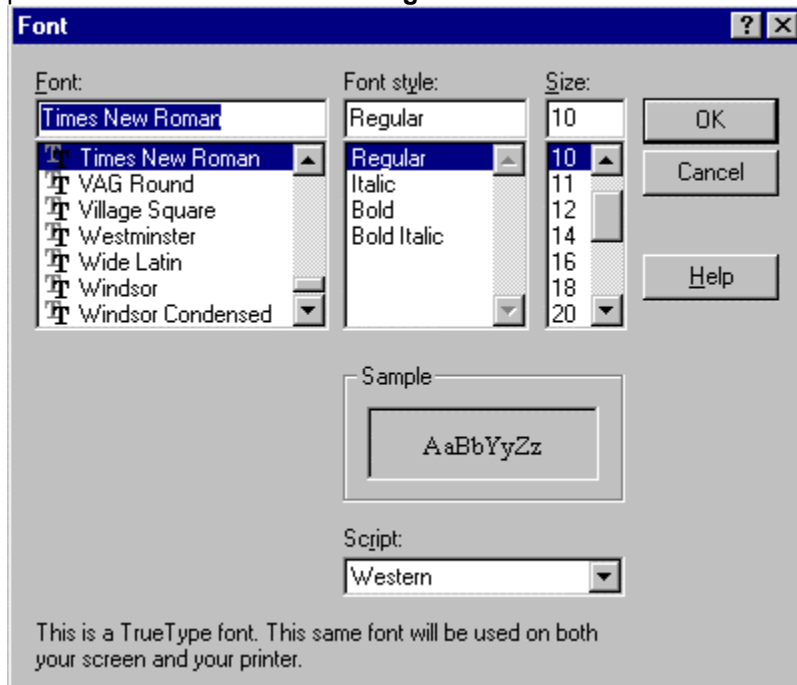

The Font Dialog

There are three controls in this dialog, along with a **Sample** window that shows the selected typeface.

Font

This shows a list of all True Type fonts in the system. If none is highlighted, the range of text or shapes selected has more than one font. Leaving this list un-selected will result in no change to the font.

Size

This shows a list of sizes for the selected font. If the size you want is not listed you may enter it in the size field. If no size is highlighted, the range of text or shapes selected has more than one size. Leaving this list un-highlighted will result in no change to the size.

Style

This shows a list of styles (or weights) for the selected font. If no style is highlighted, the range of text or shapes selected has more than one style. Leaving this list un-highlighted will result in no change to the style.

Applying the Change

Selecting a new font from the **Font Dialog** changes the typeface for any of the characters that are currently selected in your drawing. Selected text is shown in reverse color as in other Windows programs. If no characters are selected, the next character you type will be in the new typeface.

When one or more shapes that contains text, rather than the text itself, are selected, applying a change using the Font Dialog changes all the text inside the selected shapes. You can change the typeface of all the text in a drawing by using the **Select All** command (Selecting Objects), followed by the Font

command.

The typeface applied using the Font Dialog becomes the new starting typeface for text entered into empty shapes, or as background text.

Changing Text Using the Toolbar

You can also change the size and style of a shape that contains text, or text that is being edited, using toolbar buttons.

Pressing the buttons for bold, italic, etc. toggles the text style. For example, pressing the **B** button when it is not depressed, turns bold on. Pressing it again, when it is already depressed, turns bold off. If the **B** on the button is gray, then the objects or text currently selected is a mixture of bold and plain.

The following keyboard short cuts can also be used to change styles:

Bold	Ctrl+B
Italic	Ctrl+I
Underline	Ctrl+U
Superscript	Ctrl+ +
Subscript	Ctrl+ -



Superscript and **Subscript** behave in a similar way to the other styles (bold, italic and underline), except that they can only be applied to selected text and not to selected objects.



The size of text can be increased or decreased using the text sizing buttons. The "+" button increases the text size, and the "-" decreases it.

Positioning Text Inside Shapes

Text entered inside a shape does not always fill it completely. You can control the position of the text inside the shape using the **Alignment** command under the Text menu.

Text can be aligned in shapes in all possible combinations of four horizontal positions (left, right, center or flushed) and three vertical positions (top, bottom or center). The resulting twelve alignment styles are shown graphically on the Alignment menu under the Text menu.



The Text Alignment Menu

The Alignment command can be used when a shape that contains text is selected, or when a shape is open for text entry. Alignment affects both the way text is displayed within the shape, and the way the shape grows when text is added. (See [Text Entry Properties](#)).

When text is open for editing, different alignments may be applied to individual paragraphs within the same shape.

Flush alignment is similar to left alignment except that wrapped lines have smooth right edge as well as left edge. Left-aligned text has a ragged right edge. This paragraph is flush justified. All of the others are left justified.

Changing the alignment of background text often has little noticeable effect because the text fits inside its shape exactly. Changing whether it aligns right or left has no visible effect if the text is already touching both sides of its shape. The direction that the background text object will grow as text is added is affected however.

Positioning Text Along Lines

The text alignment command also changes the position of text associated with a line:

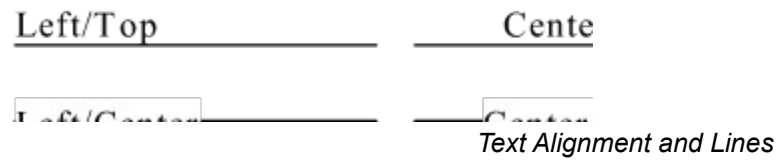

Deleting Text

If you delete text from a shape, or make the text a size smaller, so it occupies less space, the shape may or may not shrink.

The "real" size for any shape is the size set using the normal sizing commands, such as clicking and dragging on a selection handle. If the shape is forced to grow because more text is entered inside than will fit, it remembers its original size. When text is removed from the shape, it shrinks back to its original size if it can. If the shape is already at its "real" size, then removing text has no effect.

Inserting Symbols

The **Insert Symbol** command, under the Text menu, allows you to quickly insert a character in a particular font. It presents the **Insert Symbol Dialog** and is active only when a text entry session is open. Selecting one of the symbols from the dialog inserts it into the stream of text.

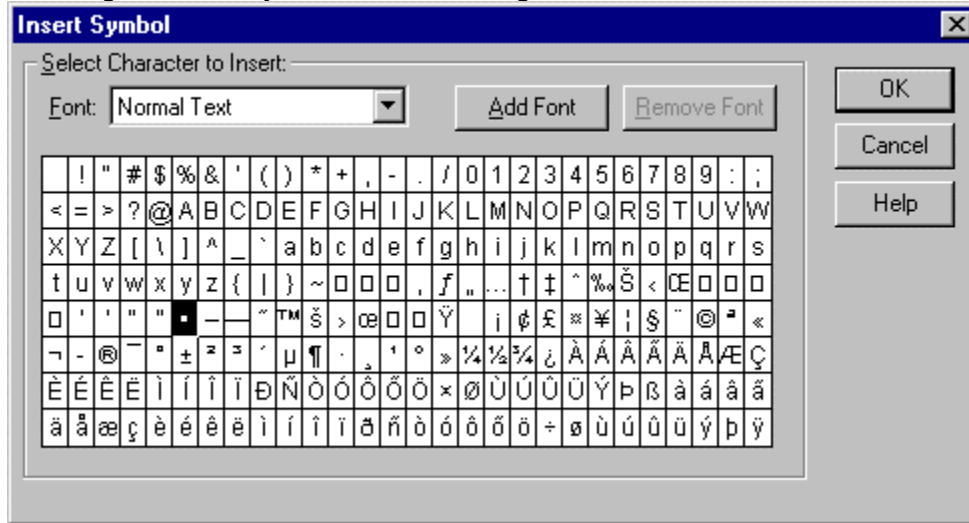

The Insert Symbol Dialog

You select a symbol by clicking on it. Pressing OK, or a double-click inserts the symbol and closes the dialog.

If the font drop-down list shows "Normal Text", the typeface of the inserted character is the same as the current font. If a specific font is selected, the inserted symbol has this font.

You can add new fonts, or remove them from the list, using the **Add Font** and **Remove Font** buttons.

Special Characters

SmartDraw supports text entry of the following special characters:

- **Tab.** You can enter a tab character by typing **Ctrl-Alt-Tab**. (Normally tabs move you from one object to another)
- **Hard Space.** Typing **Ctrl-Space** enters a hard space. This joins two words so that they are not separated by word wrapping. Hard spaces are also not hidden at the end of lines when they wrap, like normal spaces are.
- **Soft Hyphen.** Typing **Ctrl-hyphen** enters a soft hyphen. This is invisible but allows a word to be split by word wrapping, in which case it shows as a hyphen at the end of a line.

Bulleted Text



You can use the **Bullets** command, under the Text menu, to automatically format text with one of four bullet styles, with proper indentation. Bullets can be applied to the entire shape, or individual paragraphs within a shape.

- Line 1
- Line 2
- Line 3

Bulleted Text

Changing Text Color

You can change the color of text using the text color menu (under the Text menu).

You can change the color of individual characters. The color selected from the menu is applied only to the range of text currently selected.

Changes can also be applied to selected shapes that contain text. In this case, the new color is applied to all the text inside the selected shapes.

Changing Text Shadows

Whether the text in a drawing shows a shadow is determined by the properties of the current *Color and Shadow* style, and whether this has been overridden for a particular shape, using the Shadow command under the text menu. These issues are described in [Overriding Shadows](#).

What are Tables?

Tables are particularly useful for creating timelines, organizational charts, Gantt charts, software diagrams, and business forms. We'll discuss each of these at the end of this chapter, but first let's look at the basics of tables.

Normally, text entered into a SmartDraw shape occupies a single text entry area that fills the shape. However, SmartDraw also supports *Tables*, or multiple text entry areas within the same shape.

Normal Shape



Each text entry area (or *cell*) acts like a separate shape as far as text entry is concerned. Each cell has its own text alignment and background color and the text inside shrinks or grows independently of other cells.

See also:

[Adding Tables to a Drawing](#)

[Changing a Normal Shape into a Table](#)

[Rows, Columns and Cells](#)

[Adding Text to Tables](#)

[Formatting Tables](#)

[Moving Around the Table](#)

[Selecting Cells](#)

[Selecting Cell Dividers](#)

[Applying Changes to Selected Cells](#)

[Spacing Rows and Columns Evenly](#)

[Resizing the Table Object](#)

[Joining and Splitting Cells.](#)

[Inserting Rows, Columns and Cells](#)

[Appending Rows and Columns](#)

[Changing the Appearance of a Table Object](#)

[AutoFill](#)

[Using Tables](#)

Adding Tables to a Drawing



You can add a new table to your drawing simply by clicking on the table button on the top row of the toolbar. This is a shortcut to the **Add New Table** command under the Table menu.

This command presents the **Table Dialog**, which shows a list of pre-defined table formats. Pressing the OK button adds a new table with the selected format to your drawing.

In addition to the format, you can choose the number of rows and columns you want your table to have by changing the values shown in the dialog.

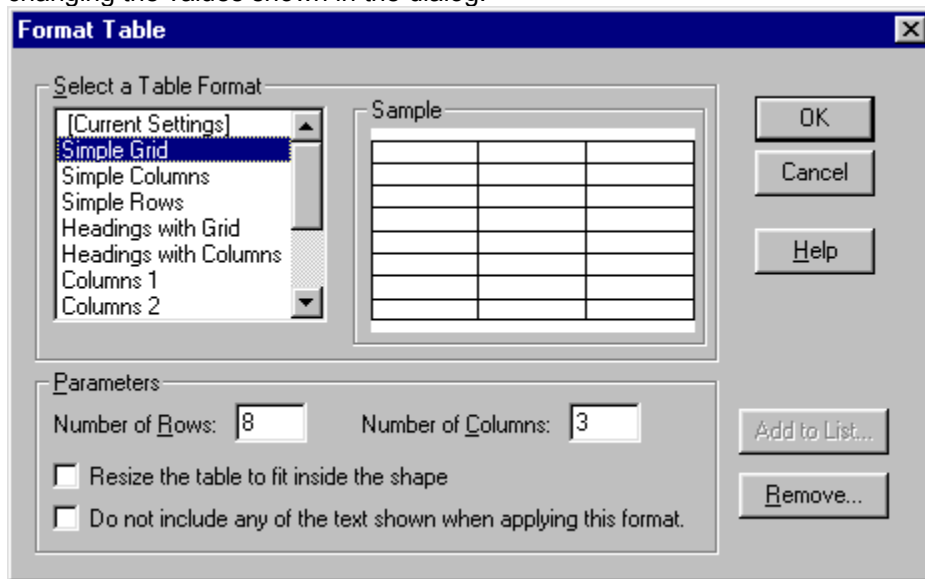

The Table Dialog

As a shortcut you can also *drag and drop* a table into your drawing from the toolbar table button. This creates a table using the most recently selected format from the **Table Dialog**.

Tables created by the table button or the **Add New Table** command are always rectangular.

Changing a Normal Shape into a Table

Existing shapes can be converted into tables by the **Convert to Table** command under the Table menu. As with a new table, you select the format from the **Table Dialog**. This inserts the desired table into the shapes currently selected. Any text inside the shapes is placed in the first cell of the table.

Non-rectangular shapes may also contain tables:

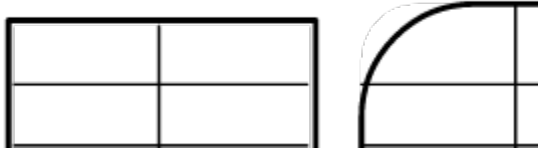

Different shapes containing the same 2x4 table.

Changing a Table into a Normal Shape

You can also change a table into a normal shape with a single text entry area using the **Convert to Text** command under the Table menu. Any text contained in the table cells is joined together as one text block inside the converted shape.

Rows, Columns and Cells

Tables are composed of one or more rows of cells. Usually the cells in each row are lined up underneath each other to form columns, but this need not be the case.

Each cell is an independent rectangular area that may have its own block of text, background color and other attributes. The boundaries of the cells are like the borders of shapes. They may have their own thickness, color and pattern. Cell borders may also be hidden. Some examples of table formats are shown below.

Note that columns may differ in width and rows may differ in height. Column arrangements may differ among rows. Cells may also span more than one row.

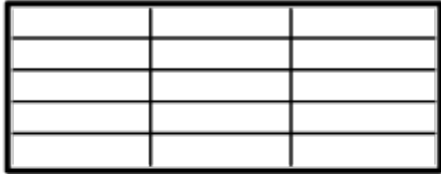

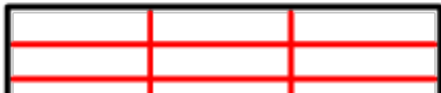

Different Table Formats

Formatting Tables

You can change the appearance and cell arrangements of an existing table, by choosing **Format Table** from the Table menu. This shows the Table Dialog (see illustration in [Adding Tables to a Drawing](#)).

SmartDraw maintains a list of table formats. These are shown in the scrolling list on the left of the dialog. A preview of the format currently selected in the list appears on the right.

The number of rows and columns in any particular format can be adjusted using the text fields in the *Parameters* section of the dialog.

A checkbox lets you can choose whether to include the text labels associated with the selected format, or not.

A second checkbox gives you the choice of whether to try to resize the table to fit inside your existing shape, or to grow your shape to fit the normal dimensions of the table. Note that it is not always possible to fit the new table format inside your shape, particularly if you add rows, since rows have a minimum height given by the height of the cell's text setting.

Adding Table Formats of Your Own

When you use the **Format Table** command on an existing table, its format is added to the list and shown in the dialog as *[Current Settings]*. You can add the current setting to the permanent list of formats by pressing the *Add to List* button. This presents the following dialog:

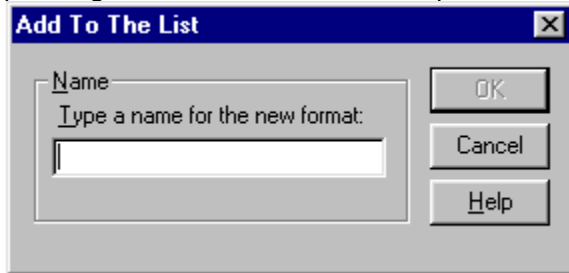

Adding the current table to the list of table formats

Enter a name for the format and press OK to add it to the list.

You can remove formats you added by selecting a format in the list and pressing the *Remove* button. Permanent built-in formats cannot be removed.

Formats you have added are stored in your personal preference file and are not available to other users sharing the same copy of the program on a network.

Adding Text to Tables

By default, tables are opened for text editing with just one click of the mouse in a cell. You can change this using the **Text Entry Properties** command under the Shapes menu as described in [Text Entry Properties](#). If you created your table by converting an existing shape, then, by default, a double-click is required for text entry. This too can be changed to a single click using the same command.

Text entry in a cell behaves exactly the same way as text entry in a shape.

Preventing Changes to Text

Sometimes you may want to prevent text in a cell from being changed (or to prevent text being entered into a cell at all), particularly in forms where you may want to freeze the field labels while allow editing in the field themselves.

You can allow or prevent text editing on a cell-by-cell basis using the **Do Not Allow Text Editing** command under the Table menu. This shows a check mark if one of the cells selected has the **No Editing** parameter set to true. Using the command toggles the ability to edit text on and off for the selected cells.

Text Resizing and Tables

If you enter enough text, the cell will be forced to grow. To maintain the row and column arrangements of the table, the cell's entire row or column will also grow.

All the cells in a table follow the text resizing rules of the shape that contains the table. (See [Text Entry Properties](#).)

By default, shapes containing tables are set to grow vertically as text is added. This means that text wraps within a cell, and rows get taller as text is added.

Shapes containing tables can also be set to grow horizontally or proportionately as text is added. Horizontal growth requires that columns (and tables) get wider as text is entered.

More text than will fit	

Change Vertically

Text Sizing in Tables

Moving Around the Table

When you are entering text into a cell, typing the **Tab key** moves the text insertion point to the next cell to the right. If the cell is at the end of a row, the insertion point wraps around to the first cell on the row below. **Shift-Tab** does the reverse.

The **Up** and **Down** arrow keys also move the insertion point up and down rows within a column.

The **Right** and **Left** arrow keys move the insertion point left and right within the text of the current cell, but to the left and right cell respectively if the cell contains no text.

Note that cells with the No Editing attribute are skipped when moving the insertion point.

Selecting Cells



Clicking and dragging the mouse within a table selects a range of cells, highlighting their centers with black, just as in Excel® and other spreadsheets. Rows and columns can also be selected by clicking at the leftmost or topmost edge of the table. When a click would select a row or column, the cursor is displayed as a wide arrow (shown at left).



Selecting the shape that contains the table implicitly selects all the cells and dividers in the table. The shape itself is selected by clicking on the border of the table. The cursor appears as the normal selection (shown at left) when a click would result in the selection of the entire shape, rather than the cells it contains.

Clicking anywhere in the table in *Multiple Select* mode always selects the shape containing the table, rather than individual cells.

Holding the **Ctrl key** down while clicking on a cell allows you to select a discontinuous group of cells, one cell at a time. Ctrl-clicking on a selected cell de-selects it.

Holding the **Shift key** down while clicking on a cell extends the selection rectangle from the *Anchor* cell to the clicked cell. The anchor cell is the cell in the table that was initially selected.

Once a cell is selected, the selection can be moved using the arrow keys. Holding the **Shift key** down while typing an arrow key extends the selection in that direction, just like shift clicking. Tabbing also moves the cell selection.

Applying Changes to Selected Cells

Once selected (either for text editing, or with a black center by "highlighting"), cells may have their attributes changed with many of the menu commands.

The **Cell Background Color** and **Cell Background Shading** submenus under the Table menu can be used to change these properties for selected cells. The equivalent commands under the Shapes menu also work in the same way.

The **Grid Line Style** and **Grid Line Color** submenus, under the Table menu, can be used to change the borders of the selected cells. (Note that the equivalent commands under the Shapes menu change these attributes for the border of the *shape*, which contains the table.)

Most of the Text menu commands may also be applied to cell contents: **Font**, **Text Color**, **Alignment**, **Bullets** etc.

Selecting Cell Dividers



You can also select the lines or dividers between cells with the mouse. When a mouse click would result in the selection of a divider, the cursor becomes two parallel lines, as shown in the margin to the left.

Selected dividers are shown as green dotted lines. Once a divider has been selected, the selection range may be extended by shift clicking on lines parallel to it. Ctrl-clicking adds just the line clicked-on to the selection range.

You can change the attributes of the selected dividers with the menu commands in the **Grid Line Style** and **Grid Line Color** submenus. The equivalent commands under the Lines menu also make the same changes.

Partially Selecting Row and Column Dividers

Normally, when a cell divider is clicked with the mouse, the whole divider for the row or column is selected. If the **Alt key** is held down while clicking, however, only the segment of the row or column divider for the local cell is selected. Alt clicking on other divider segments adds them to the selection. Holding down both the **Alt** and **Ctrl** keys toggles the selection state of a divider segment.

This feature allows the application of attributes to parts of a row or column divider, and more importantly, allows parts of them to be moved!

Moving Cell Dividers

Clicking on a row or column divider not only selects it, but also allows you to move it. You can increase or decrease the width of columns and the heights of rows by dragging the dividers with the mouse.

When whole column dividers are moved, only the width of the column to the left of the divider is affected. The columns to the right remain the same size. Hence the table grows wider or narrower to accommodate the change in width of the divider's column. The same principal also applies to row dividers.

Using the **Alt key** to select a segment of a column divider allows the small selected segment to be moved, changing the width of the immediately adjoining cells. This is one way to create tables with cell arrangements that are more complicated than regular rows and columns.

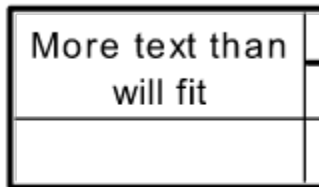

Moving Partial Column Dividers

When column dividers are moved while holding down the **Alt key**, the column to the right of the divider becomes narrower as the one to the left becomes wider (and vice versa). The width of the table remains unaffected, unless forced to grow to maintain a minimum width for a column.

Changing the Width and Height of Cells.

There are several ways to adjust the height and width of cells, and hence rows and columns, within a table.

Dragging Cell Dividers

We have already described how row and column dividers can be dragged to change the width of columns and the height of rows, using the mouse.

The invisible *Snap-to* grid affects the position of cell dividers. When the *Snaps* are active, row heights snap to whole line heights, as determined by the height of the first line in the table. Column dividers fall only on the lines of the grid. This makes it easy to re-align column dividers that have been separated by dividing cells or by dragging partial dividers.

The far right and bottom edges of the table behave like dividers and can be dragged with the mouse. The divider cursor appears just inside these edges. Dragging on this "phantom" divider changes the width of the last column, or height of the bottom row.

Spacing Rows and Columns Evenly

These commands, under the Table menu, make all the rows or columns in the table the same height or width, while changing the size of the table as little as possible.

Resizing the Table Object

Resizing the object that contains the table scales the table as a whole to fit the new dimensions of the object.

The combined table and object cannot be reduced in height to less than the minimum height of all the rows. You can quickly minimize a table's height by shrinking the object vertically as far as it will go.

Holding the **Shift key** down while resizing the object with a corner selection-handle will scale the object, and the table, proportionately.

Joining and Splitting Cells.

The **Join Cells** and **Split Cells** commands, under the Table menu, allow you to create complex table structures.

The **Join Cells** command joins selected cells into one cell, combining any text in the cells into a single block of text. When cells from multiple rows are selected, cells adjacent to each other in the same row are joined first. Cells adjacent to each other in the same column are joined only if they have no selected neighbors in the same row.

Joining cells in the same row simply removes the cell divider(s) between them.

More text than will fit	

Join Cells in a Row

More text than will fit	

Joining Cells Horizontally

Joining cells in the same column creates a single cell that spans the rows containing the selected cells. Cells that span more than one row always span a whole number of rows. It is not possible to create a cell that lies partially in a row.

More text than will fit	

Join Cells in a Column

More text than will fit	

Joining Cells Vertically

The **Split Cells** command does the reverse of **Join Cells**. If a cell spans more than one row, splitting creates a cell for each row spanned. Any text in the split cell is placed in the top, or left, cell.

If no selected cell spans more than one row, all selected cells are split into two cells within the same row and occupying the same space as the original cell: A vertical cell divider is added to the center of the cell.

Inserting Rows, Columns and Cells

You can insert columns and cells anywhere in the table using the **Insert** command under the Table menu.

When whole rows are selected, the **Insert** command shows **Insert Row**. It adds the same number of rows as are selected, inserting them above the uppermost selected row.

1	
2	
3	
4	

Insert

1	
2	
3	
4	

Insert Row

When whole columns are selected, The **Insert** command becomes **Insert Column**. It inserts the same number of columns as are selected, inserting them to the left of the leftmost selected column.

1	
2	
3	
4	

Insert

	1	
	2	
	3	
	4	

Insert Columns

When a rectangular block of cells is selected that is not a whole row or a column, the **Insert** command says **Insert Cells** and presents a dialog with four options for inserting:

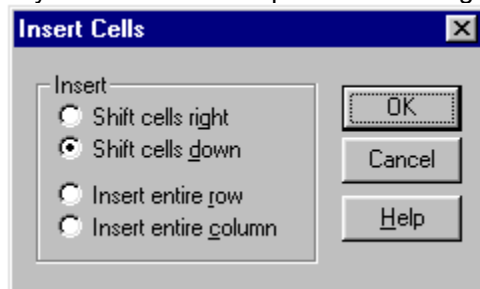

Insert Cells Dialog

In addition to inserting whole row and columns, cells may be inserted in just the selected rows or

columns. This provides an easy way to shuffle a whole column down (or a row right), to insert a missing value, for example.

1	A
2	B
3	C
4	D

Shift Cells Down

	A
	B
1	C
2	D
3	
4	

Inserting cells within a column

Shift Cells Right

	1	A
	2	B
3	C	
4	D	

The same table inserting within a row

Appending Rows and Columns

The **Format Table** command (Table menu) provides an easy way to append rows and columns to a table. This command presents the **Table Dialog**. The format of the currently selected table appears as *[Current Settings]*. You can append rows or columns by increasing the values for the number of rows or columns shown in the dialog and pressing OK.

You can also completely change the arrangement of cells in the table by selecting one of the other formats from the scrolling list shown in the dialog.

Deleting Rows, Columns and Cells

You can remove selected cells from the table with the **Delete Cells** command. This works in essentially the reverse way of the **Insert Cells** command described above. When whole rows and columns are selected, the Delete command shows **Delete Rows** and **Delete Columns**, respectively.

When you delete partial rows and columns with the **Delete Cells** command, values are moved up or left, but the total number of rows and columns remains fixed. To remove spare rows or columns, if desired, simply make a second Delete operation.

You can use the **Format Table** command to remove rows and columns from the bottom and right edge of the table. Just reduce the number of rows and columns shown in the Table dialog and press OK.

Deleting, Copying and Pasting Text

With a single keystroke you can delete the text contents of a cell, without removing the cell itself. Typing the **Backspace** or **Delete** key erases the text in all selected cells.

The content of selected cells can be copied to the clipboard using the **Copy** or **Cut** commands under the Edit menu. Pasting the content back into a SmartDraw table preserves its row and column arrangement along with fonts, alignment and other text attributes. You can even paste the table data from SmartDraw into another application, such as an Excel spreadsheet or Word table, and it will retain its tabular format.

The reverse also works. **Pasting** tabular data from another program into a SmartDraw table preserves the row and column arrangements of the data, placing each field in its appropriate cell. This allows data from spreadsheets and other applications that generate tabular data to be formatted as a table in SmartDraw.

Changing the Appearance of a Table Object

As we discussed above, the color, pattern, borders and text properties of cells may be changed by first selecting the cells and then using the appropriate menu commands under the Table and Text menus. Selecting the entire object containing a table implicitly selects all the cells and dividers in the table, and any changes to the attributes then apply to the entire table.

AutoFill

The row and column headers in a table are frequently a series of numbers, months or days. SmartDraw can create these series for you, with the **AutoFill** command under the Table menu. This presents the AutoFill dialog.

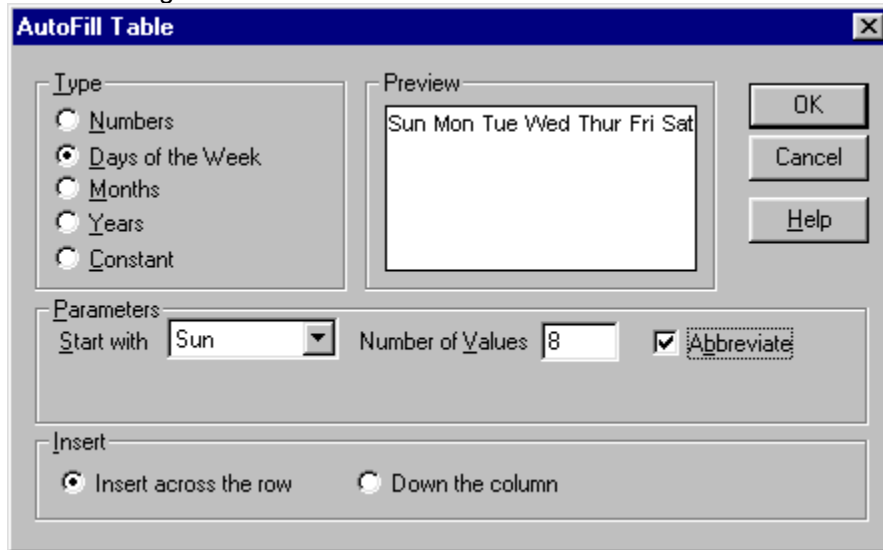

The AutoFill Dialog

SmartDraw will automatically type the selected series across a range of rows or columns, beginning with the currently selected cell.

There are five choices for the type of series: Numbers, days-of-the-week, months, years, and a constant value.

For days-of-the-week and months, the sequence can begin at any value, and it repeats until the *Number of Values* is reached. A checkbox lets you choose between full and abbreviated names for the days or months. A preview appears showing the current selections.

For years and other series of numbers, a prefix and a suffix can be specified to create a string. For example, the parameters:

Parameters					
Starting Value	1	Ending Value	5	Prefix	Q
Increment	1	Number of Values	4	Suffix	, 1998

Result in the strings Q1, 1998, Q2, 1998, Q3,1998 and so on.

The radio buttons at the bottom of the dialog indicate whether to insert the series across the row containing the currently selected cell or down its column.

Using Tables

The ability to divide shapes into multiple text areas opens up a whole new world of flexibility in diagramming:

Timelines

Timelines are diagrams that consist of one large table.

Tasks	Mon	Tue	Wed	Thur	Fri	Sat	Sun
Begin Work							
Milestone 1							
Milestone 2							
Milestone 3							
....							

Timeline

SmartDraw's table features make it very easy to maintain and manipulate complex tables.

Software Diagramming

Many of the symbols used in software diagramming require independent text entry areas:

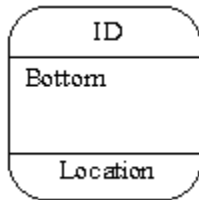

Multi-Text Entry Symbol

Organizational Charts

Multiple text entry areas in a single shape allow you to store complex information in organizational charts or family trees.

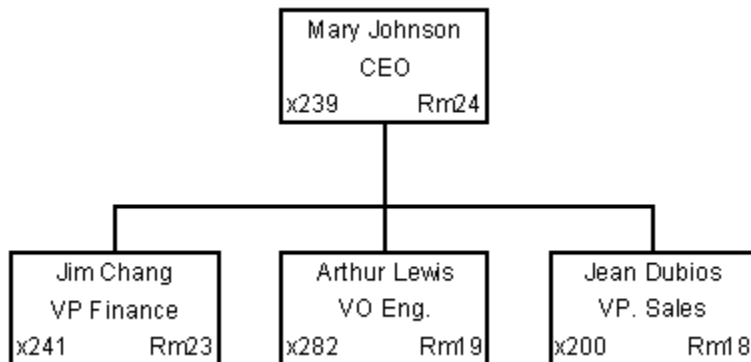

Organizational chart with multiple fields per position

In the example above, each position has four cells: Name, title, extension and room. The last two share

the same row. The cell dividers are white.

Forms

SmartDraw's sophisticated table functions make it an excellent form designer:

Name	Water Smith			
Street	46 Main Street			
City	Westchester	State	CA	Zip 92171
Country	USA			

Designing Forms with SmartDraw

View the templates in the Forms drawing-type for more examples.

Arranging Objects

SmartDraw includes several features that make it easy to align shapes and lines, and to control their front-to-back order. These commands are grouped under the **Arrange** menu.

See also:

[Using Snaps](#)

[Aligning Objects](#)

[Making Objects the Same Size](#)

[Spacing Objects Evenly](#)

[Changing the Front-to-Back Order](#)

[Locking Objects](#)

Using Snaps

The **Snaps** are a grid of imaginary lines that extend from the minor ticks on the rulers. When snaps are turned on, the centers (or sometimes the edges) of shapes and lines automatically align themselves with the tick marks on the rulers as they are created, moved, or resized with the mouse. This makes aligning the centers of very easy: You simply drag them with the mouse. The grid used by the snaps is the same one that is displayed by the **Show Grid** command under the View menu.

You can choose whether the **Top-Left** or **Center** of your objects will snap to the grid. You set this property for the entire drawing in the **Define Rulers and Grid dialog**.

The default setting of **Center** is best when lines are used to link shapes together, as in flowcharting. The **Top-Left** setting is best when the edges of shapes must line up, as in form design or when drawing floor plans.

When you move or resize objects using other methods, such as with the arrow keys, they do not align with the snaps. This makes it easy to make fine adjustments in position without turning the snaps off.

The **Use Snaps** command, under the Align menu, toggles the snap mechanism on and off. When Snaps are on, the menu item shows a check mark.

Aligning Objects

The edges of several objects can be aligned with each other using the **Align** command under the Arrange menu.

The **Align** command aligns the edges of selected objects with the *target* selected object. The target selected object is the one that shows solid handles, rather than hollow handles. It is the most recently selected.

The **Align Left** and **Right** commands align the left or right edges of the selected objects with the left or right edge of the target object, respectively.

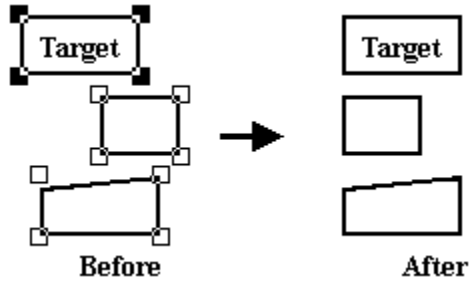

Align Left Command

Aligning the **Top** and **Bottom** works similarly.

The **Center Vertically** command aligns the midpoints between the left and right edges of the objects. **Center Horizontally** works similarly, aligning the midpoints between the objects' top and bottom.

Making Objects the Same Size

You can make several shapes the same size in height, width or both using the **Make Same Size** command under the Arrange menu.

Like the **Align** command described above, **Make Same Size** uses the target selected object as the template for changes to all the other selected objects. The **Make Same Size Width** command makes all non-target selected objects the same width as the target. **Height** and **Both** work similarly.

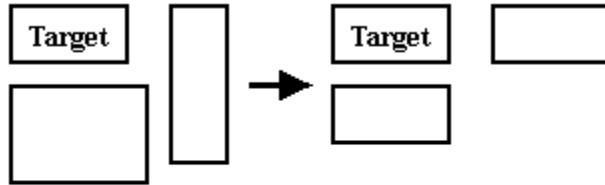

Before

After

Make Same Size Command

Objects that can only shrink or grow proportionally, maintain their proportions under this command.

Spacing Objects Evenly

Using the **Space Evenly** commands, you can arrange three or more shapes so that there is the same amount of space between them. This is useful for creating an equally spaced array of lines or shapes. The **Space Evenly** menu item, has three choices on its sub-menu: **Horizontally**, equalizes the space between objects in the horizontal direction only. **Vertically** does the same in the vertical direction and **Both** does the same in both directions at the same time.

Centering the Drawing on the Page

The **Center Drawing on Page** command under the Arrange menu can be used to move all the objects in the drawing so that they are centered in the minimum number of pages needed to print them. The drawing is also moved to the top-left of the 50x50 inch drawing area. This command applies to **all** objects, not just selected objects.

If your drawing does not fit on one page, you can still print it on a single page by checking the **Print on One Page** check box in the Print dialog.

Changing the Front-to-Back Order

Objects may lie on top of other objects. You can change the front-to-back order of the objects in your drawing using the **Bring to Front** or **Send To Back** commands under the Arrange menu.

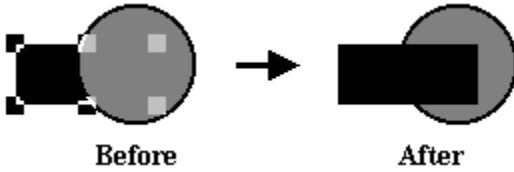

Bring to Front

Bring to Front moves any selected objects in front of the non-selected objects. **Send to Back** does the reverse. These commands have no noticeable effect unless objects overlap one another.

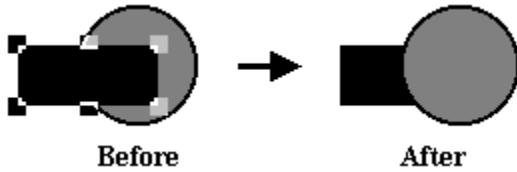

Send to Back

Locking Objects

You may lock or unlock selected objects using the **Lock Object** command. Locked objects show selection with gray handles instead of black and cannot be moved until they are unlocked. This is useful if you want to place an object behind others and don't want to accidentally move it while clicking on the objects in front of it. Locked objects cannot be opened for text editing. However, their properties (color etc.) can be changed using the menu commands.

Linking Objects to Each Other

SmartDraw lets you link objects together so that they **stay connected when you move or re-size them**. This is particularly useful for flowcharts.

The most common case is a line linked to two shapes. Moving one of the shapes changes the size and shape of the line as shown below.

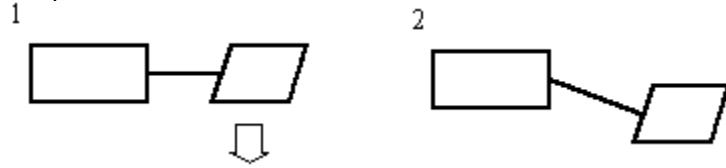

A Line Linked to Two Shapes

See:

[Linking a Line to a Shape](#)

[Infinite and Fixed Connection Points](#)

[Turning Linking On and Off](#)

[Linking Shapes to Each Other](#)

[Linking Lines to Each Other](#)

Linking a Line to a Shape

When line linking is enabled, you can link a line to a shape by moving one end over the border of the shape, either by resizing or moving the line with the mouse.

When the end of the line approaches the shape's border, a series of round solid circles appear on the shape, indicating the points on the border where the line may link. These are called **connection points**. This is shown below for fixed connection points. (Connection points can also be infinite, see [Infinite and Fixed Connection Points](#)).



Connection Points



The end of the line then snaps to the closest connection point and the mouse cursor becomes an "anchor". Releasing the mouse while in this state establishes a link between the line and the shape.

You can even link one line between two shapes in a single drawing operation. Just click on one of the line tools on the toolbar (but not the automatic connector) and release. (Your cursor now looks like a pencil). Touch the pencil to the border of one shape and click down with the mouse. Drag the pencil to the edge of the second shape and release. The two shapes are now linked to the line, and they will stay connected even if one or both of the shapes are moved or resized.

Line Linking and Flowcharts

Linking lines to the edges of shapes is a key feature when creating flowcharts. By linking lines in this way, you can move the shapes and the lines remain attached.

Normally in flow diagrams of all types, you link a line to the center of the side of a shape. If the centers of shapes joined by a line do not align exactly with each other, the line will be kinked. Because of this, the centers (rather than the top-lefts) of shapes are set to snap to the grid when drawing flowcharts. This is one of the parameters set when you choose a Flowchart type from the **New Drawing** dialog.

If you choose a floor plan type, or a drawing where exact placement of edges is important, then shapes are set to snap their top-left corners to the grid.

The way shapes snap to the grid in the current drawing is set in the **Rulers and Grid Dialog** ([Setting the Ruler Scale](#)).

Breaking a Link

Links may be broken using the reverse of the link creation process. First, click on the line, so that it shows round handled where it connects to the shape. Then grab the handle and pull it away from the shape to break the link. When only one end of a line is linked to shape you can also break the link by moving the line away from the shape. Deleting either object also breaks the link.

Infinite and Fixed Connection Points

Shapes can have either **Fixed** or **Infinite** connection points.

With fixed points, shapes have 16 fixed connection points, four at the corners of the shape, four in the center of the sides, and one between each these points. Fixed connection points make it easy to connect a line exactly in the center of a side and are the best choice for simple flow charts.

With infinite connection points, lines can connect to any point on the perimeter of the shape. Infinite connection points allow you to connect many lines to the same side of a shape. Certain library symbols can only have fixed connection points, but you can adjust the position of the fixed points using the Edit Symbol dialog ([Changing the Settings for a Symbol](#)).

You can choose the kind of connection points a shape has using the **Connection Points** command under the shape menu. This presents a dialog, which explains each choice and allows you to change it.

Linked Targets and Linked Objects

In any linking relationship, the object that displays the connection points is the **Linked Target**, and the object linked to it is called the **Linked Object**. The target object usually controls the positioning of the linked object. If the target is moved, the linked object either moves, or re-sizes to maintain the link.

Lines are allowed to have one or two targets. With one target, lines move when their target moves. With two, they change shape and/or re-size when one of their targets moves.

When a line that is linked to one target is moved, the link is broken. When a line that is linked to two objects is moved, all three are moved as a group.

Turning Linking On and Off

You can turn linking on and off. This is very useful when you want to draw a finely detailed picture, and you don't want lines and shapes that you draw close to others to automatically link to them.

The **Allow Lines to Link** command toggles the ability of lines to link to other objects. New drawings of the type that make use of line linking, like flowcharts, usually have this turned on automatically.

The **Allow Shapes to Link** command toggles the ability of shapes to link to each other. In most drawing-types this is turned off.

Linking Shapes to Each Other

When the **Allow Shapes to Link** item under the Arrange menu shows a check mark, one shape can be linked to another. However, shapes can never link to lines where a line is the target. Instead the *line* must be linked to the *shape*.

When shapes link to each other, any of the connection points on the linked shape can snap to any of the connection points on the target shape. Shapes can only link to one target at a time.

This feature is useful if you want to attach a background text object to a shape so that it follows the shape around when the shape is moved or re-sized.

Linking Lines to Each Other

Lines can link to other lines. This is useful for creating branched networks of lines that remain attached when their target objects (whether shapes or lines) change size or move.

Using Automatic Connectors

One of the most powerful features of SmartDraw is the use of **Automatic Connectors** to create regular arrangements of shapes. Examples include organization charts, fishbone diagrams, network diagrams and even flow charts.

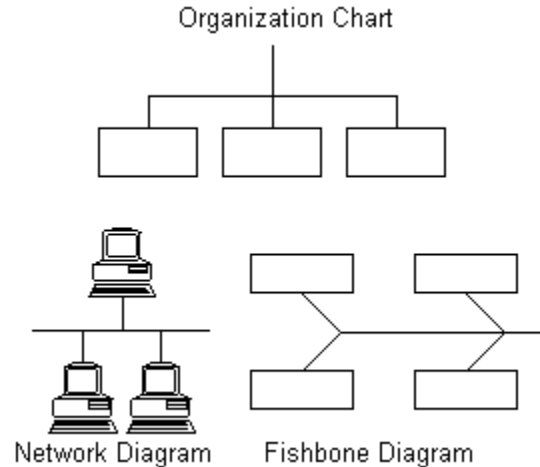

Using Connectors

Automatic Connectors are special line objects that both shapes and other lines may link to. A connector is **programmed** to arrange the objects linked to it in a particular pattern. As shapes are linked to a connector, the other shapes already linked to it adjust to accommodate the new shape and maintain the arrangement. In the example below, a new shape is added to a connector that maintains a horizontal organization chart arrangement.

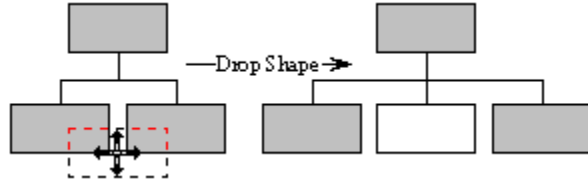

Adding a new shape to a Connector

The new shape (white) is dropped between the two existing shapes and is automatically inserted between them.

See:

[Adding Connectors to a Drawing](#)

[Changing a Connector's Shape](#)

[Adding Shapes to a Connector](#)

[Linking Automatic Connectors to Each Other](#)

[Adjusting the Connector Spacing](#)

[Changing an Automatic Connector's Appearance](#)

[Using Automatic Connectors in Flow Charts](#)

Adding Connectors to a Drawing

You add automatic connectors to a drawing in the same way you add any other object: using drag and drop or the pencil drawing method.



SmartDraw offers an **Automatic Connector** tool on the **Program Toolbar**. Dragging an object from this tool creates a horizontal connector with a linear arrangement. Holding the **Shift key** down while you drag creates a vertical connector.

Many of the diagram templates also offer ready-made connectors in other arrangements in their document toolbar. For example, the organization chart template offers a selection of connectors suitable for drawing organization charts.

Changing a Connector's Shape

Once you have added an automatic connector to a drawing, you may change the arrangement it maintains (or its **shape**) using the **Change Connector Shape** command on the Lines Menu. (This replaces the **Change Line Shape** command when a connector is selected).

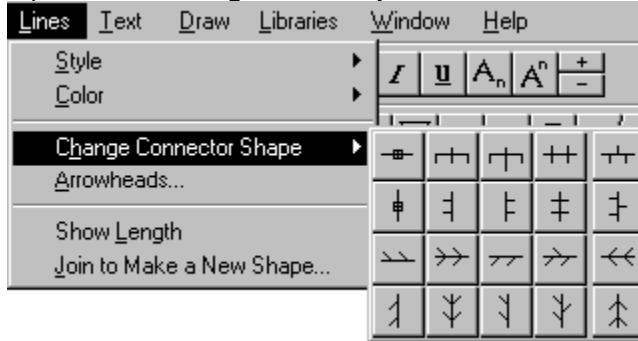

Change Connector Shape

The Flip command can also be used to create additional variations.

When no shapes are linked to a connector, it appears as either a vertical or horizontal line. Its arrangement does not become apparent until two or more shapes have been linked to it.

Adding Shapes to a Connector

When you move a shape or line close to an automatic connector, connection points appear, and the outline of the moving object jumps to the closest one, showing the position the object would take if linked.

Releasing the mouse links the object to the automatic connector, inserting the object at the link point.

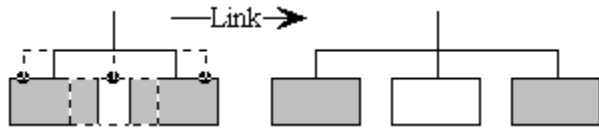

Linking to an Automatic Connector

Moving a shape away from the automatic connector disconnects it, and the shapes still linked to the automatic connector move together to fill the space.

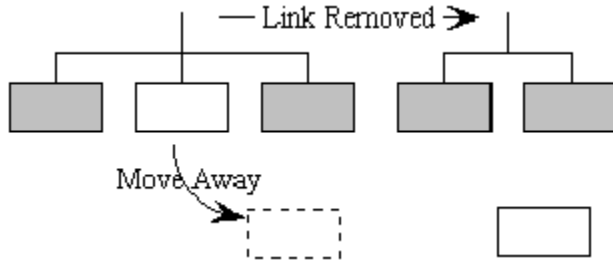

Breaking a Link to an Automatic Connector

Dragging a shape from one connection point to another changes the order of the shapes.

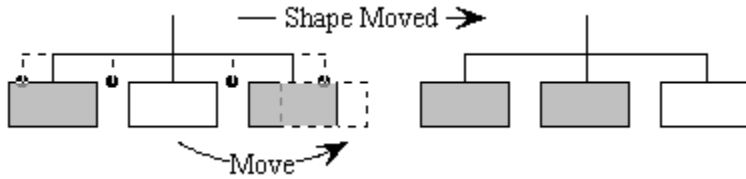

Re-arranging a Link to an Automatic Connector

Linking Automatic Connectors to Each Other

Automatic connectors can be linked to each other to create more elaborate diagrams.

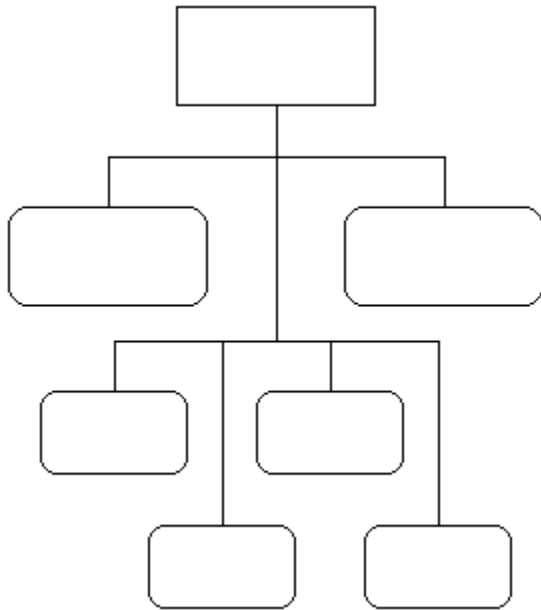

Organization Chart with Two Connectors

In the example above, the connector used to arrange the four smaller shapes is linked to the one used for the two larger shapes. This in turn is linked, like a line, to the top shape.

Adjusting the Connector Spacing

There is always an equal amount of space between the edges of shapes linked to an automatic connector. This spacing [C] is controlled using the grow handles at each end of the main connector line.

The length of the lines connecting the main line to each shape is controlled by grow handles at the end of the first and last of these lines (where they connect to the shapes) [B].

The length of the line connecting the connector to another object [A] is controlled by the grow handle at the end of this line.

These relationships are shown in the figure below.

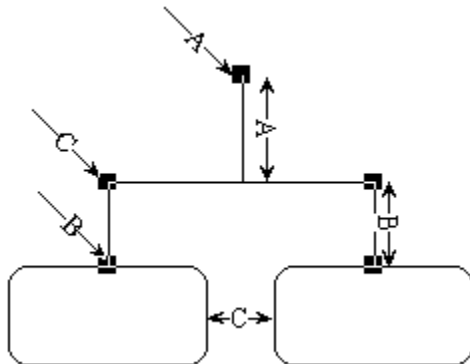

Grow Handles and their Parameters

Some connector arrangements have two lines that may connect to other shapes at each end of the main connector line [A]. Only one of these can be linked to another object at a given time.

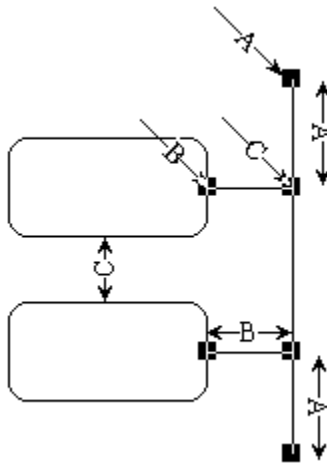

Side Arm Connectors and their Parameters

The side arm lines of an automatic connector can be set to zero length using the grow handles. This gives a clean end to the main connector line, where desired:

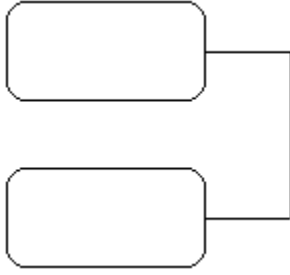

Automatic Connector with a Side Arm Length of Zero

Changing an Automatic Connector's Appearance

A automatic connector has the same attributes as a line, and the Lines Menu commands can be used to set its thickness, color and style.

Automatic connectors also can show arrowheads. These appear on the lines connecting objects to the main connector line. **Right facing arrowheads always point to the linked objects**, regardless of their direction relative to the main connector line. Left facing arrowheads point towards the main connector line.

Automatic connectors cannot have text associated with them (see [Attaching Text to Lines](#)) and cannot be rotated.

Using Automatic Connectors in Flow Charts

Linear automatic connectors can be useful as components in a flow chart. A linear connector connects shapes in either a perfectly horizontal or vertical line, as shown below:

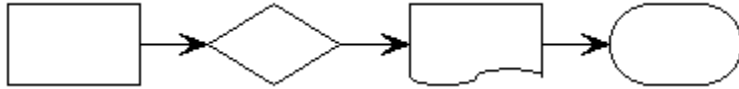

Horizontal Automatic Connector with Arrowheads

To branch, other automatic connectors can be linked to the shapes attached to the first automatic connector. This is shown below:

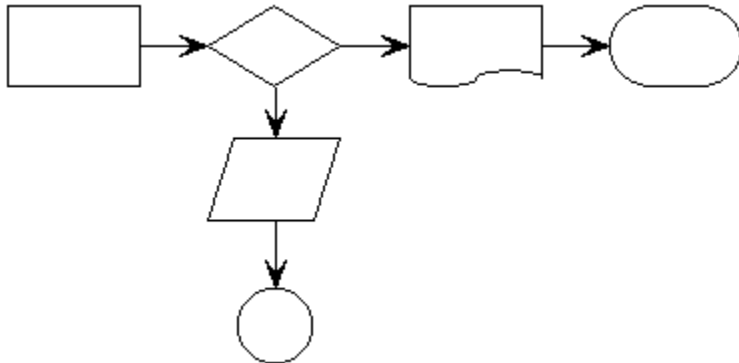

Horizontal and Vertical Automatic Connectors with Arrowheads

Next, normal segmented lines can be used to create additional connections:

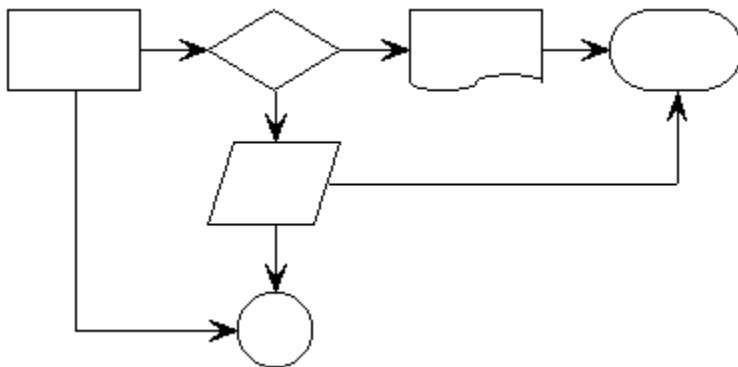

Flow Chart with Segmented Lines and Automatic Connectors

Now, adding another step to the main horizontal or vertical automatic connector is as easy as drag and drop! The chart below was derived from the one above by simply dropping the delay symbol on the horizontal automatic connector.

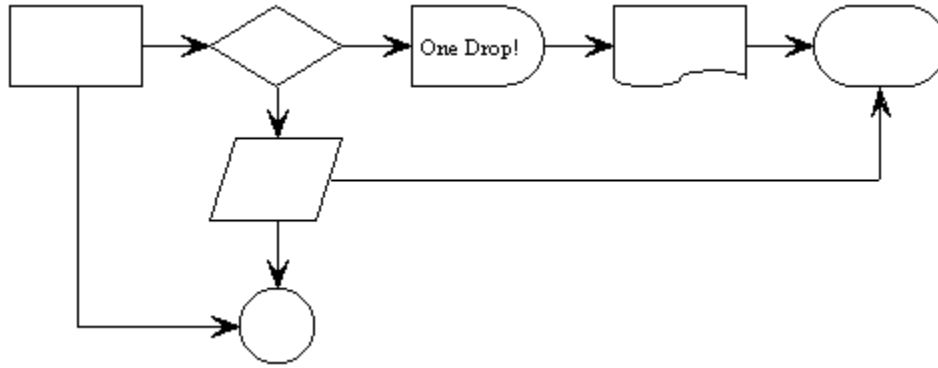

Chart is Automatically Reformatted

Beginning Users

While automatic connectors are a powerful addition to flowchart design, most beginning users will be better off using normal "straight" lines and links as described in [Linking Objects to Each Other](#).

Libraries

In addition to the built-in shapes shown on the toolbar, SmartDraw provides thousands more in *Symbol Libraries*.

Collections of symbols are stored in libraries. These are files on your hard disk.

Libraries are usually collections of symbols that are used by a particular type of diagram. SmartDraw has dozens of libraries with symbols for flow charts, computer networks, space planning, clip art, engineering, and many other kinds of diagrams.

Library Windows

The symbols in a library are displayed in a *Library Window* that "floats" above the program window. Up to 16 library windows can be open at the same time, each showing the contents of a different library.

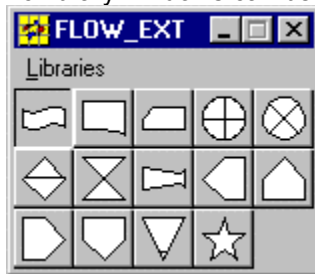

A Library Window

A library window shows rows of buttons, each displaying a different symbol. The name of its library is shown in the window title bar.

A library window has its own menu. This is used to change the library displayed in the window, create new libraries and edit the contents of the current library. It is the same as the **Libraries** menu on the main menu bar.

Pressing the minimize button at the top right of the window shrinks the library to a minimized window at the bottom of your screen. This is useful if you want to temporarily move a library window out of the way.

Changing the Size of the Buttons

The **Small**, **Medium** and **Large** commands on the Libraries menu control the size of the buttons in a library window. You may select the size that best suits both your display resolution and your eyes.

Complex clip art drawings generally look better with larger buttons. These commands have no effect on toolbars, which have buttons the same size as those on the **Program Toolbar**.

Symbol Names

You can use the **Names** command under the Libraries menu to show the name of each drawing on its button instead of its picture. This is the same name that shows in a ToolTip when the mouse is moved over the symbol button.

Symbol Types

There are two types of library symbols: **Automatic** and **Metafile**. Automatic symbols are native SmartDraw objects, either alone or in groups. Metafile symbols are images in Windows Metafile format (WMF).

Both types have similar properties when added to a SmartDraw document: They can be rotated, flipped, colored, typed-into and manipulated in many of the same ways. Only automatic symbols have all the special properties of the toolbar shapes, however.

Adding Symbols to a Drawing

Clicking on a button in a library window is the same as clicking on a shape button in the Toolbar.

Clicking and dragging on a library button drags and drops a copy of the symbol shown on the button into the drawing. Clicking and releasing the button changes the cursor to a pencil. Drawing with the pencil (by holding down the mouse and dragging) draws a new copy of the symbol.

When an automatic symbol, made up of more than one native object or group, is dragged onto the page, each of its components is drawn as a separate object at its original size.

Removing a Symbol from a Library

Remove a symbol from a library by clicking on its button in the library window, and then selecting the **Remove Symbol** command in the Libraries menu.

To change the image of a symbol, you must remove it completely and then add a new image.

See also:

[Opening a Symbol Library](#)

[Searching for Symbols](#)

[Changing the Settings for a Symbol](#)

[Adding New Symbols to a Library](#)

[Document Toolbars](#)

[Creating a New Library](#)

[Library File Organization](#)

[Transferring Drawings Between Libraries](#)

[Sharing Libraries on a Network](#)

Document Toolbars

You can change a library window into a **Document Toolbar** by dragging it to the top of a document window. As the library window approaches the toolbar area, its gray outline changes to toolbar shape. Releasing the mouse changes it to a document toolbar. This is called **docking** the window.

You can do the reverse by dragging the toolbar away from the top of the document window, so that the library window once again *floats* over your drawing.

Each document can have only one toolbar at a given time. Attempting to dock a second toolbar will fail. However, you can dock a different toolbar to each open document.

When a document is maximized to fill the entire program window, the document toolbar appears as a third row of buttons below the program toolbar.



Document Toolbar below the Program Toolbar.

Bringing a new document to the front, with a different document toolbar, changes the third row.

A document toolbar behaves just like a library window: You can add symbols to it using drag and drop, you can transfer symbols to and from other libraries, and so on.

When a document is saved, its relationship to its toolbar is saved too, and the next time it is opened, the toolbar remains in place. Many of the SmartDraw templates use this feature to automatically open their own toolbars.

The most recently docked library becomes the default toolbar for all new documents that don't already have their own toolbars. You can use this feature to create your own "permanent" third row to the program toolbar: Simply dock your favorite library, and all new documents will automatically have this toolbar.

Opening a Symbol Library

You find and open libraries using the **Open Symbol Library** command under the **Libraries Menu**.

This shows the **Open Library** dialog:

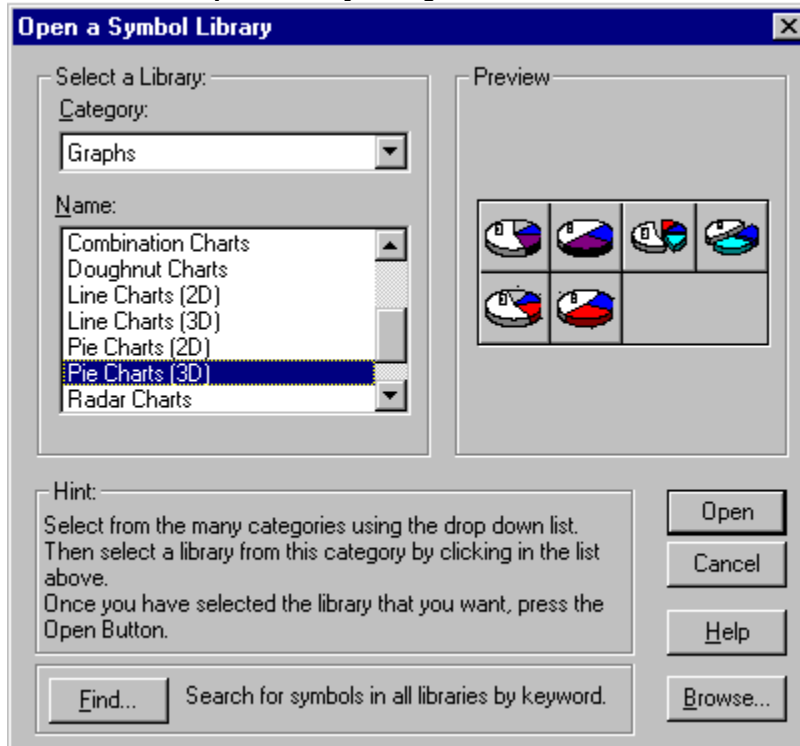

Open Library Dialog

SmartDraw's libraries are organized into a dozen or more **Categories**. These are shown in the drop-down **Category** list.

Each category contains a group of libraries whose names are shown in the **Name** list. As each one of the names in the list is selected, a preview of the library symbols appears at the right. This makes it easy to browse through all the libraries looking for a particular symbol.

The **Libraries** menu lists the most recent libraries you have opened, and shows a check mark next to the names of those that are currently open. Selecting a library from the menu either opens it or brings it to front (if it is already open).

Any library window that was left open when the last drawing was closed is always re-opened automatically (in the same location) whenever a drawing is opened again.

Like SmartDraw documents, you can also open a library file by dragging it from the Windows Explorer (or File Manager) and dropping it anywhere in the program window.

Searching for Symbols

You can search for a symbol by name by pressing the **Find** button in the **Open Library** dialog.

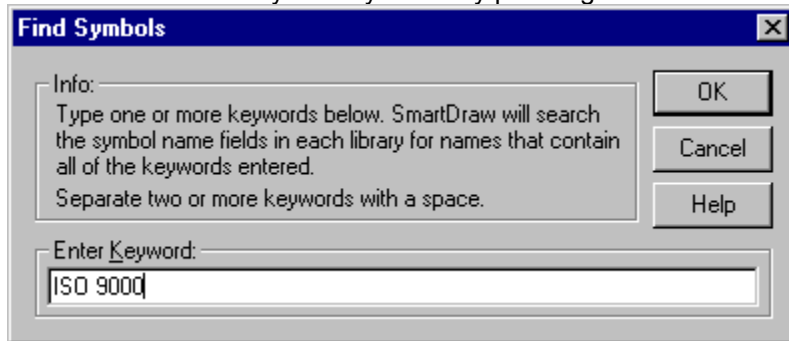

Find Symbol Dialog

If you enter a word in this dialog and then press OK, SmartDraw will find all the libraries that contain a symbol that has this word in its name or in its keyword description. The names of these libraries are displayed in a special category called **Results of Find**. The most recent list of libraries found in a search is remembered, even between program sessions, until the next **Find** operation is performed.

Library File Organization

All of the symbol libraries that come with SmartDraw are installed into a file folder called **LIBRARY** inside the SmartDraw program folder. The **LIBRARY** folder itself contains a folder for each category. The library files themselves have a file extension of *.SDL and reside in the category folders.

If you are experienced in the use of the file system, you can create your own categories by adding new folders to the LIBRARY folder and then moving library files into them.

You can also open libraries from outside the LIBRARY folder using the **Browse** button in the **Open Library** dialog . This presents the File Open dialog with an SDL extension.

Changing the Settings for a Symbol

SmartDraw symbols have special properties used by SmartDraw to control the way they change size or color and the way they display text.

You can change the properties (but not the image) of an existing symbol. To do this, either double-click on the drawing's button in the library window, or select the button and then select the **Edit Symbol** command in the Libraries menu. This presents the **Edit Symbol Dialog**.

You can use this to change both existing symbols and new symbols that you are adding to a library.

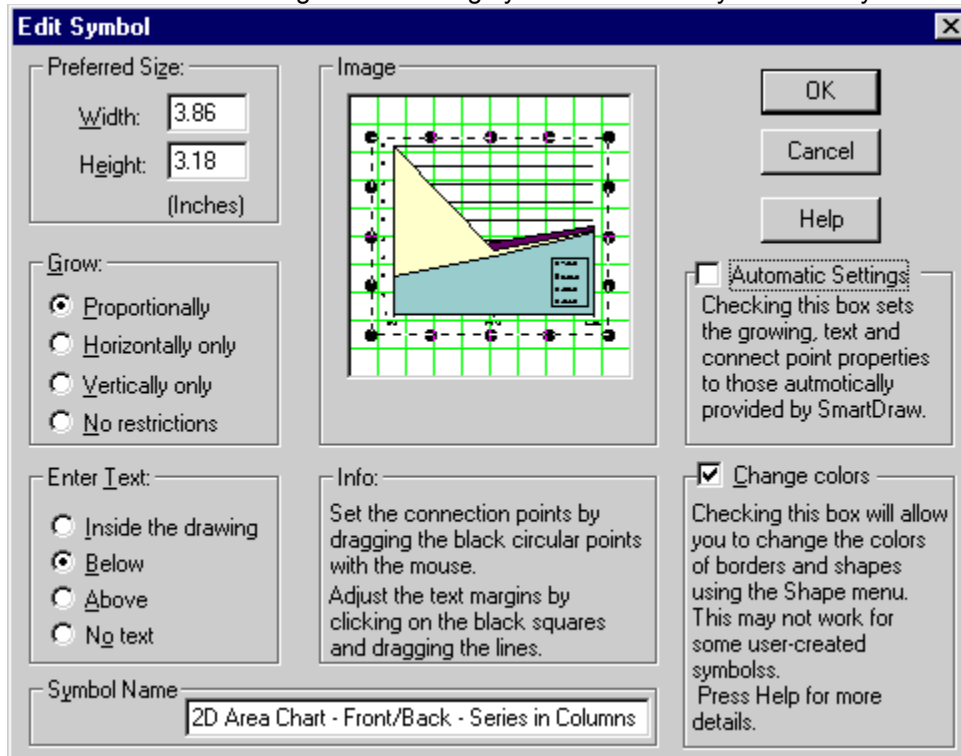

The Edit Symbol Dialog

Automatic Settings

If this box has a check mark (**Automatic** format), the symbol was originally created with SmartDraw and it will behave as a native SmartDraw object when added to a drawing. It automatically has the properties of a native SmartDraw object and you cannot override these using this dialog. .

If the box is unchecked, the symbol behaves like an imported image. You can set its properties (width, height, resizing behavior and text entry) using this dialog. (**Metafile** format).

Symbols created in SmartDraw itself can have either format.

Symbols created outside SmartDraw cannot have automatic settings so for these symbols the Automatic checkbox is unchecked and disabled.

Preferred Size

The width and height fields control the size of the symbol when it is created using Drag and Drop. If the **Grow** setting is set to **Proportional**, changing one value changes the other, so as to maintain the same proportions.

This setting is grayed out for automatic symbols composed of more than one native object, since their original size is maintained.

Grow

The four radio buttons control the way the symbols can be resized. These settings are grayed out for automatic symbols.

Proportional drawings have only four grow handles (one at each corner) and maintain their proportions when re-sized.

Horizontal Only drawings have only two grow handles and can be re-sized only in the horizontal direction. This is good for drawings that represent horizontal lines.

Vertical Only drawings have only two grow handles and can be re-sized only in the vertical direction. This is good for drawings that represent vertical lines.

No restrictions allows drawings to grow in all directions without maintaining proportions. These drawings have the usual 8 grow handles.

These values can be changed for symbols already added to a drawing using the **Shape Sizing** command ([The Shape Sizing Dialog](#)).

Enter Text

You can enter text into symbols. This text can be **Inside the drawing** like the standard 24 shapes, or **Above** or **Below** it. The fourth choice, **No text**, means that the drawing will not respond to the normal text entry commands.

If **Inside the drawing** is selected, four margin lines appear inside the Image window. These should be adjusted so that the text area within the four lines does not overlap the boundaries of the symbols.

These settings are also grayed out for automatic symbols. The native objects in these symbols retain their own text sizing properties.

Image Window

The image window shows the symbol image against a grid of green lines. A dotted border shows the edges of the rectangle that encloses the drawing.

For non-automatic symbols, each drawing has 16 **Connection Points** shown as solid black circles. These are the points at which lines and other shapes will link to this drawing. Automatic symbols use the connection points of their native objects.

Clicking on the circles and dragging with the mouse button held down moves them. The connection points should be arranged on the borders of the drawing. To be active, connection points must lie outside the margin lines (whether text is entered **Inside the Drawing** or not).

You can finely adjust the position of connection points using the **F5**, **F6**, **F7** and **F8** keys. The point you last clicked on, moves left, right, up or down by 1 pixel when these keys are typed.

When the text setting is **Inside the Drawing**, four margin lines appear. Clicking on the square handles at each end and dragging can move these. By default, these are set to create the smallest text entry area possible between all four lines. This should be expanded to allow the largest area that still forces all text to lie within the borders of the shape. When text is entered **Above** or **Below** the drawing, the margin lines are ignored.

Colors

Checking this box allows SmartDraw to change the color of the fills, lines, border and text that show in non-automatic symbols. The style and thickness of borders and lines can also be changed. These settings are controlled by the Shape menu, not the Line or Text menu.

The color of the text, lines and borders follows the **Border Color** setting. The fills follow the **Fill Color**. Transparent fills are not affected by the fill color.

If this box is not checked, the drawing behaves like an imported image. Applying a border style places a border around the symbol but does not change the content of the symbol itself.

The substitution of colors for lines, fills etc. may not work for all symbols. If the image contains bit mapped images these may be unaffected by checking the color box. The rules are: All pens used follow the border style and color. Black fills follow the border color. Text color follows the border color. Non-black fills follow the Fill color. Transparent fills used by the drawing are left alone.

If you check this box you should experiment with a copy of the symbol to see the effects of color changes. If these are not satisfactory, return to the dialog and un-check the box again.

The colors and other properties of automatic symbols can always be changed. Remember that checking this box causes a copy of the symbol to adopt the current default color scheme when added to a drawing.

Symbol Name

You can assign each symbol in a library an optional name using the **Symbol Name** field. This is the name that shows in the ToolTip when the cursor is moved over the symbol in the library window.

It is also the name that is displayed on the button if you choose the **Names** command from the Libraries menu.

The naming feature is useful when more detail is required than an image might show. For example, an IBM PS/2 computer may appear to be similar to another PC when looking at the thumbnail image shown on the symbol buttons. Their names are quite different however, and showing the names in a ToolTip makes them easily distinguishable.

Names are also used when searching for a symbol by word. ([Searching for Symbols](#)). Additional keywords to be matched in searches may be entered following the name. Just put a semicolon after the name, then list your keywords, each separated by a space. Words after the semicolon are not displayed in the ToolTip, or when names are shown on the buttons.

Adding New Symbols to a Library

Adding Symbols from SmartDraw

Adding a new symbol to a library is a simple **Drag and Drop** operation. Any object, or collection of objects dragged from a SmartDraw document window and dropped onto a library window, may be added as a new symbol.



This operation is an extension of a standard object move operation. If, while moving one or more objects using the mouse, you position the cursor over an open library window, the cursor changes to the **Library Drop Cursor**, shown at the left. If you release the mouse at this point, the **Edit Symbol** dialog ([Changing the Settings for a Symbol](#)) appears. The new symbol, composed of the objects that you were moving, shows in the Image window. Pressing OK adds the objects to the library as a new symbol.

You can use the Edit Symbol dialog to set the appropriate properties for your new symbol, before adding it. You can also use it later to modify the properties, if necessary.

Note that because collections of native objects can be stored and retrieved in libraries unchanged, you can use symbol libraries as a **Scrapbook** for pieces of diagrams you might want to reuse.

Adding a Symbol From Another Program

You can use almost any Windows drawing program to create a new symbol. All that is required is to be able to load an image to the Windows clipboard in standard Windows *metafile* format. Metafiles are placed on the clipboard when you use the **Copy** command under the Edit menu in most graphics programs.

To add a symbol to a currently open library, first copy it to the clipboard and then select the **Add New Symbol** command under the Libraries menu. The **Edit Symbol** dialog is presented just as if you had dropped an image onto the library.

Images from other programs cannot have **automatic** settings.

Transferring Drawings Between Libraries

Copying a symbol from one library to another is also a simple drag-and-drop procedure: Click on the drawing that you want to copy, then drag with the mouse, just as if you were going to drag a copy into the drawing, but instead of releasing the mouse button over the drawing window (which adds a copy to the drawing), release it over the library window, or document toolbar, that you want to copy the symbol to.



When releasing the mouse would result in copying the symbol to another library, the cursor will change to the shape shown at the left.

This is a useful feature if you want to collect the symbols you use most often into one or two libraries. You can also use it to sort the order of the drawings in the library by dragging them in the order you want to a new library.

Creating a New Library

You can create your own symbol libraries using the **Create New Library** command in the Libraries menu. This displays a standard Save File dialog. If you enter name for the new library and press OK, an empty library with that name is created and opened.

Unless you create the new library file in one of the existing category folders within the **LIBRARY** folder in the program folder, it will not show using the **Open Library** dialog.

Your new library window will show the new name but, because it is empty, it will show no buttons. You can now add drawings to the new library by dragging them from SmartDraw drawings, other libraries, or by using the **Add New Symbol** command as described above.

Sharing Libraries on a Network

Libraries can be shared by multiple users on a network, or by multiple document toolbars used by the same user.

When a library is opened more than once, the second and later clients open the library as read-only. Only the first client to open the library has write permission. Read-only libraries cannot be edited, and symbols cannot be added or removed.

Joining Lines to Make a New Shape

You can create a new shape by joining together any collection of lines and curves that form a closed loop. Use the **Join to Make a New Shape** command, under the Line menu.

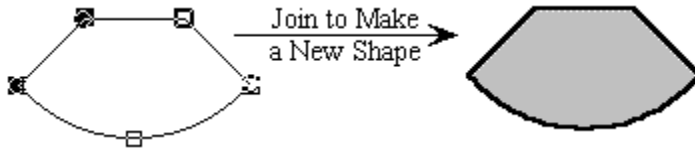

Joining Lines to Make a New Shape

The newly created shape is like any other: It can be filled. It can be rotated and you can type text into it. You can also drop it on a **library window** or **document toolbar** to create a new library symbol.

Shapes created this way are called **Polygon Shapes**. They have infinite connect points, and their text editing areas that are assigned automatically.

If the lines do not quite touch each other to form a closed loop, the Join command will fail. If this happens use a view of 200% or more to clearly see the ends of the lines you are trying to join, and adjust them until they meet.

Changing Existing Shapes

Any of the 24 built-in SmartDraw shapes, and **Polygon Shapes** made by joining lines, can be split apart into their component lines and curves using the **Edit Shape Outline** command under the Shapes menu. This is the reverse of the **Join** command described above.

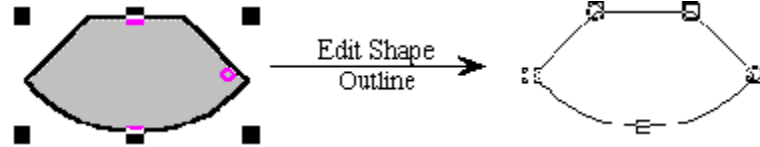

Separating a Shape into its Components

Once separated into lines and curves, the outline of the shape can be adjusted and then re-combined into a re-designed shape.



Re-designing a Shape

Grouping and Ungrouping

Two or more objects may be combined into a **Grouped Object** using the **Group** command under the Arrange menu. The **Ungroup** command reverses this. Ungrouping can also separate imported images into native SmartDraw shapes (page 160).

Properties of Grouped Objects

Object groups behave as a single object in some respects, and as individual objects in others. The following operations treat a group as a single object:

- *Clicking on any member of the group selects the group.*
- *Changing properties (color, thickness, font etc.) affects all members of the group.*
- *Moving the group moves all members of the group.*
- *Sizing the group sizes all members of the group.*
- *Rotation rotates the group as if it were a single object.*
- *Flipping reflects the group as if it were a single object.*
- *Duplicating, copying and pasting applies to the group as a whole.*

The following operations treat a group as individual objects:

- *Lines link to individual objects within a group.*
- *Shapes attach to automatic connectors and other shapes as individual objects.*
- *Text is edited and entered independently for each object in the group.*
- *Other files remain hyperlinked to individual group members after they are grouped.*

Grouping objects that are already in a group with other objects simply combines them all into a single group. There is no hierarchy of groups.

Ungrouping Imported Images

You can also ungroup most imported images into native SmartDraw objects. This is described in [Ungrouping Imported Images](#).

Adding Groups to Symbol Libraries

A grouped object may be added to a library as a new symbol by simply dragging it onto a library window. Groups retain their properties as library symbols, and are drawn as a grouped object when introduced into a drawing.

Note that grouping a grouped object with other objects and then ungrouping it again will break it apart into its constituents.

The SmartDraw Drawing Area

SmartDraw has a drawing area with a fixed size of 50x50 inches, and it is one of the few drawing programs that will let you draw a diagram this large.

Very few printers support paper sizes that are this large, so the drawing area is divided up into page-sized rectangles (or *tiles*) shown with dotted lines.

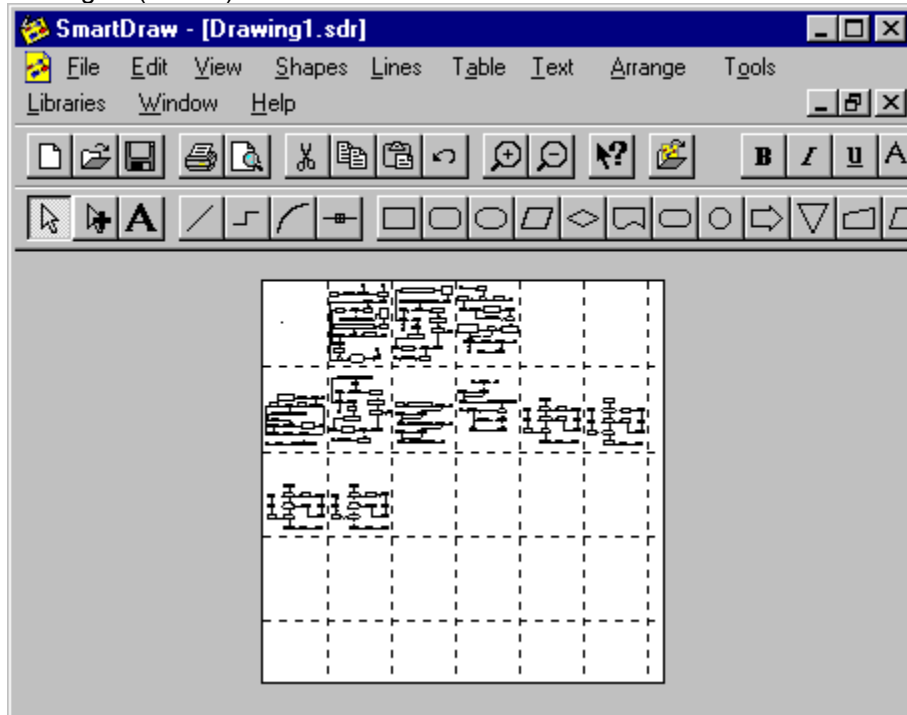

Fit to Window View Showing Page-sized Tiles

Since the dotted lines represent the dimensions of the page currently selected for this document, they change position when you change page orientation from **Portrait** to **Landscape**, or change the paper size using the Page Setup command under the File menu.

If the currently selected printer supports large format paper sizes (like E-sized) you can select this as the current paper size and the dotted page boundaries will reflect this, allowing you to print a large drawing on a single sheet.

Changing the View

While all SmartDraw drawings can occupy an area of up to 50x50 inches, unless your drawing is very large, you normally work only with a small part of this potential area, up in the top left corner.

The View menu items **200%**, **150%**, **100%**, **75%**, **50%**, **Fit to Page**, **Fit to Window** and **Custom...** control the scale used to display a drawing in its drawing window. 100% is the scale used by most Windows programs to show objects at their natural size. The other scales make objects look smaller or bigger than they really are.

These scale factors have no effect on the size of shapes and lines when they are printed out, only as viewed on the screen.

As you change the view, SmartDraw attempts to keep all of your objects in the visible part of your window. If this is not possible, it tries to keep all *selected* objects in view. If this is not possible, it tries to keep the center of the selected set of objects centered in the window.



You can cycle up and down through the views using the Scale Up and Scale Down toolbar buttons.

Choosing the **Custom...** command under the View menu presents the **Set Window Scale Dialog**. You can use this to set the scale to any values between 5% and 400%.

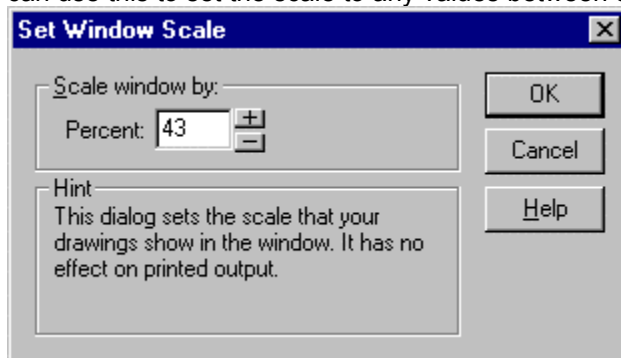

Set Window Scale Dialog

The **Fit to Page** selection scales the window to show at least one complete page.

The **Fit to Window** selection shows the whole 50 inches of the drawing in the document window.

Setting the Ruler Scale

Two rulers normally appear at the top and left of the document window. You can set their divisions and units using the **Set Rulers and Grids Dialog**, which is accessed via the **Define Rulers and Grid** command under the View Menu.

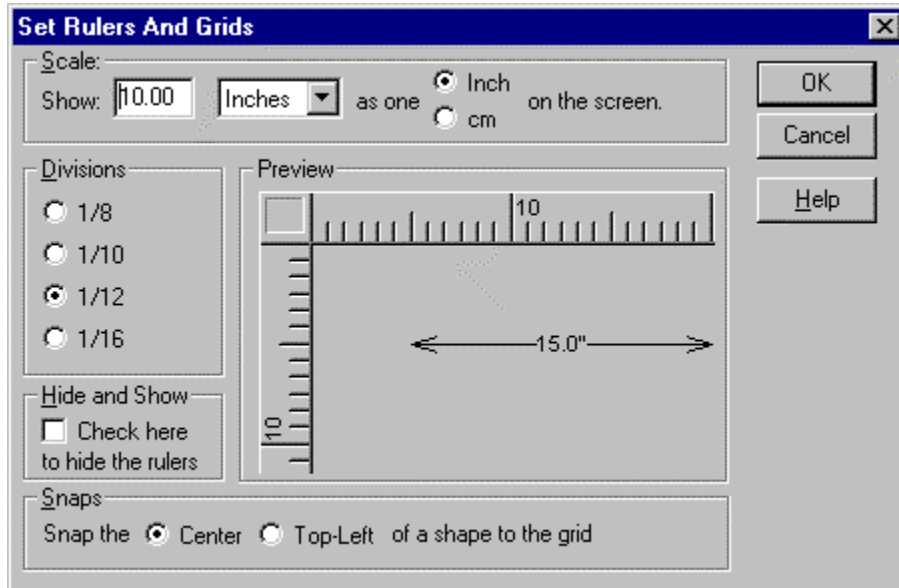

Set Rulers and Grid Dialog

Entering a value for Show sets the number of units for each major division on the ruler. Major divisions can either occur every inch or centimeter on the screen. This is set using the **Inch** or **cm** radio buttons.

If the **Show** value is not a whole number, the major divisions are scaled to slightly more or less than an inch (cm) so that they are separated by whole number of units.

The actual units chosen using the drop down list do not change the appearance of the rulers, but do affect the units shown for lines with **automatic dimensioning**. This is described in more detail on page 97.

The number of subdivisions per major division can also be set using radio buttons, with a choice of 8, 10, 12, or 16.

The rulers can be hidden by checking or un-checking **the Hide and Show** checkbox in the dialog.

The **Snaps** setting, at the bottom of this dialog, controls the way shapes align to the snap-to grid. The default setting snaps the centers of shapes to the grid. This is important if line linking (see [Linking a Line to a Shape](#)) is used to connect shapes because it ensures that the lines connecting the centers of shapes remain perfectly horizontal or vertical.

Printing

For drawings that fit on one page, printing is very straightforward. Pressing the **Print** button on the toolbar prints a single copy to your default printer.

Using the Print command under the File menu presents the Print dialog, which gives you many more options, including the number of copies and the range of pages to print. The range is only relevant when a drawing extends across multiple pages. The shape and size of these pages are determined by the **Page Setup** selections, described in [Page Setup](#).

Printing Multiple Page Drawings

SmartDraw does not normally print the entire 50x50 inch drawing area. It prints only the rectangular array of pages that the drawing actually touches. If your drawing lies completely within one page, only that page is printed. If your drawing extends across a page boundary, it is printed on two or more pages.

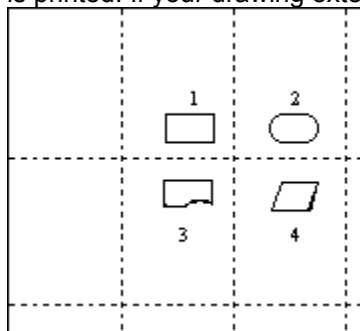

Multiple Page Drawing

In the example above, four pages are printed, marked 1,2,3, and 4. The top-left page of the array of pages that contain the drawing is printed as page 1. The remaining pages are then printed, starting with the page to the right of page 1, and proceeding from top left to bottom right across each row.

When a page range is specified in the Print dialog, the page numbering follows this scheme. For example, to print the bottom right page only, in the example above, you would specify a range of page 4 through 4.

If your drawing occupies more than one page, an ideal printer would print to the edge of each sheet of paper so that the drawing could be pieced together afterwards to form one continuous sheet. However, almost all printers have a gap, between $\frac{1}{4}$ inch and $\frac{1}{2}$ inch, at the edge of each page, into which they cannot print. SmartDraw takes this minimum margin into account and shows the *printable* area of each page with dotted lines on your screen.

Printing on One Page

Even if your drawing takes up more than one page on the screen, you can still print it on one sheet of paper by checking the **Print on One Page** box in Print dialog. You won't see this dialog if you print by clicking on the Print button in the toolbar, so use the Print command on the File menu instead.

For best results, choose a page orientation (Portrait or Landscape) that matches the shape of your drawing (tall or wide). Of course, if your drawing is very large it may not be readable when printed on one page.

See also:

[Page Setup](#)

[Print Preview](#)

The Print Dialog

Page Setup

The **Page Setup** command, under the File menu, is used to set the following parameters:

- Page orientation
- Paper size
- Printer
- Printer properties

This information is stored with each drawing. If you change a printer property using this command it will affect only the drawing in the front-most window. Changes will have no effect on any other program, any other drawing, or on the global printer settings.

The **Page Setup** command presents the **Page Setup Dialog**.

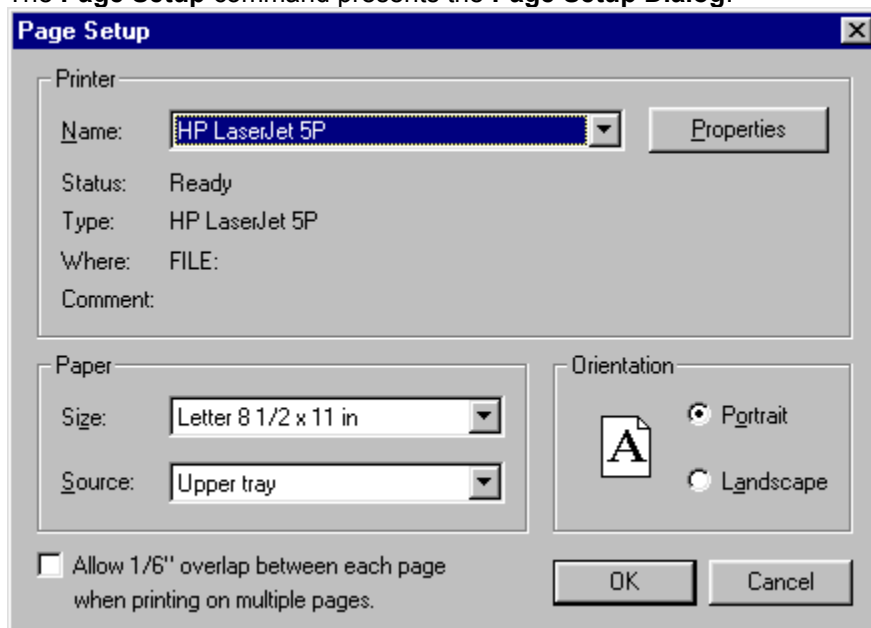

The Page Setup Dialog

The printer assigned to a particular drawing may be either the **Default** or a **Specific** printer.

The **Default** printer is the one currently specified in the Windows **Control Panel**. If the printer assigned to a drawing is set to the default, its assigned printer changes to the new default each time you change the default printer, either by using the Control Panel or by moving the drawing to a different computer. New drawings are set to the default printer when they are created.

If you choose a printer other than the default, you assign a **Specific** printer to that drawing. The next time you print it, it will automatically select the same printer, no matter what the default printer setting is. If this printer is no longer available, you are prompted to select another when the drawing is re-opened.

The remaining controls in the Page Setup dialog let you choose a paper size and orientation. If you have more than one drawing open, these choices apply only to the current front-most drawing.

Overlap

Checking the checkbox marked **Allow 1/6" Overlap...** causes a small strip of each page to be printed again on the pages that surround it (on multiple page drawings). This makes it easier to paste together

the pages of large drawings.

Print Preview



The **Print Preview** command puts SmartDraw into Print Preview mode. The Print Preview button on toolbar (shown at left) can also be used as a shortcut for this command.

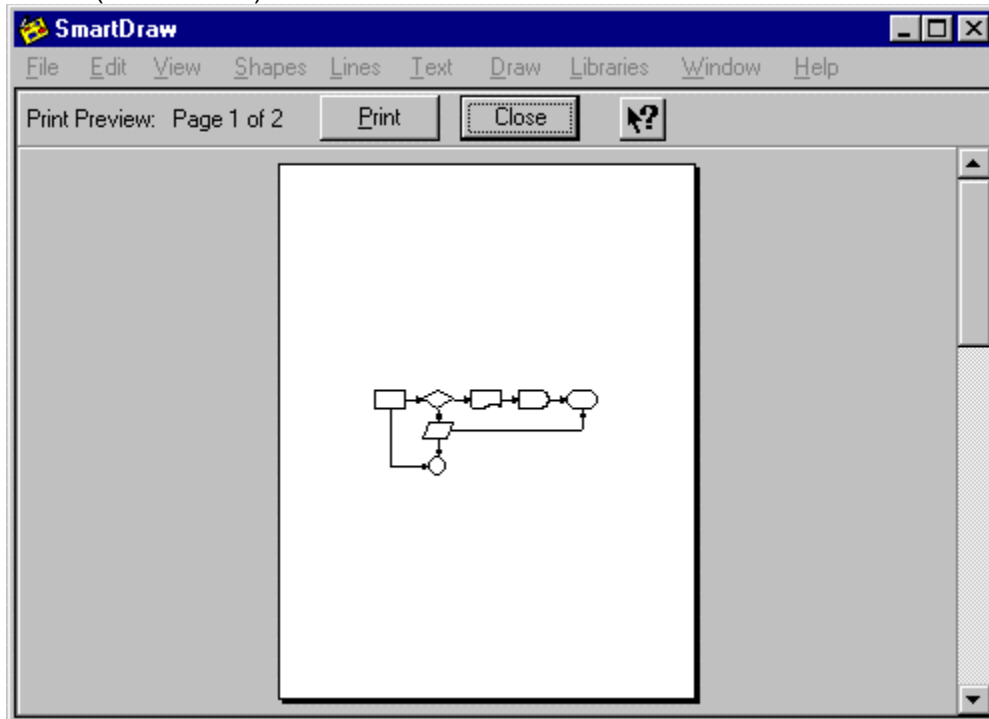

Print Preview Mode

In print preview mode, the program window shows a representation of a printed page. For drawings that require more than one page to print, the scrollbar on the right controls which page is previewed. The current page number is shown at the top left of the toolbar.

The toolbar has three buttons: **Close**, which ends the preview mode, **Print**, which ends the preview and presents the Print dialog, and a Help button.

The Print Dialog

The **Print** command under the File menu presents the **Print Dialog**. You can use this to control the range of pages printed, the number of copies and several other options.

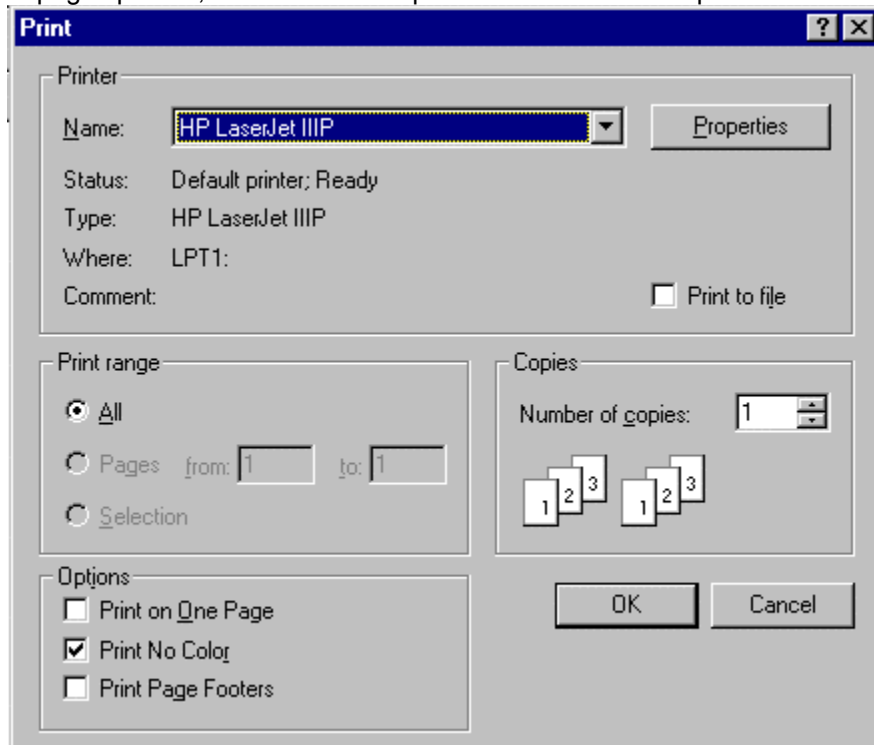

The Print Dialog

Printer

The currently selected printer is shown at the top of the dialog. You can change to a different printer using the drop down list.

Selecting a Range to Print

The Print dialog provides three choices for the range of pages to print.

- **All**, causes all the pages that the drawing touches to be printed.
- **Selection**, causes all the pages that the *selected* objects in the drawing touch to be printed.
- **Pages**, allows a *range* of the pages touched by the whole drawing to be selected for printing.

Printing Multiple Copies

You can print more than one copy of your selected range of pages, by entering the number of copies you want in the **Copies** field.

The **Collate Copies** checkbox determines the order in which the copies of the pages of a drawing will be printed.

If the range selected requires only one page to print, this setting has no effect.

If the range selected involves more than one page, then checking the box will cause multiple copies to be printed so that the pages are in collated order: page 1, 2, 3..., followed by page 1, 2, 3... and so on.

Un-checking the box, will cause all copies of page 1 to be printed, followed by all copies of page 2 and so on. Non-collated printing (where available) is often faster than collated printing.

For printers that do not have enough memory to store a whole page (like dot matrix printers) the Collate Copies box is often checked and made inactive.

Print on One Page

Checking this box causes the entire drawing to be scaled down and printed on a single page. This may result in reduced legibility. This affects only the *printed* drawing, and will not change the view of the drawing on your screen.

Print No Color

Checking this box causes the drawing to be printed in black and white only. All borders, lines and text are made black, and the background and shape fills are made white. This often gives sharper results with non-color printers, and requires much less printer memory than printing in color.

Print Page Footers

Checking this box causes a footer showing the name of the drawing, the number of the page, and the current date and time to be printed at the bottom of each page.

Define Footer

This button becomes visible when the **Print Page Footer** box is checked. Pressing it brings the **Define Footer Dialog** into view.

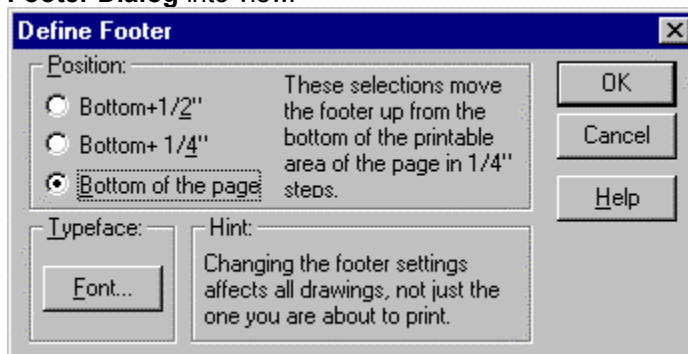

The Define Footer Dialog

Changing the setting of the **Position** radio buttons, changes the position of the footer. The footer can be placed at the very bottom of the printable area of the page, or 1/4 inch or 1/2 inch above the bottom.

Pressing the **Font** button displays the Windows **Font Dialog**. This lets you choose the font, size and style for the footer text. A point size of 10 or less is recommended.

Print To File

Checking this box causes the printed image to be stored in a file on disk instead of being printed to the printer.

Selecting with the Tab Key

If no objects in your drawing are selected, typing the **Tab key** selects the first one. If one or more objects are already selected, typing the **Tab key** moves the selection from the current *Target* object (Aligning Objects) to the next object in the drawing.

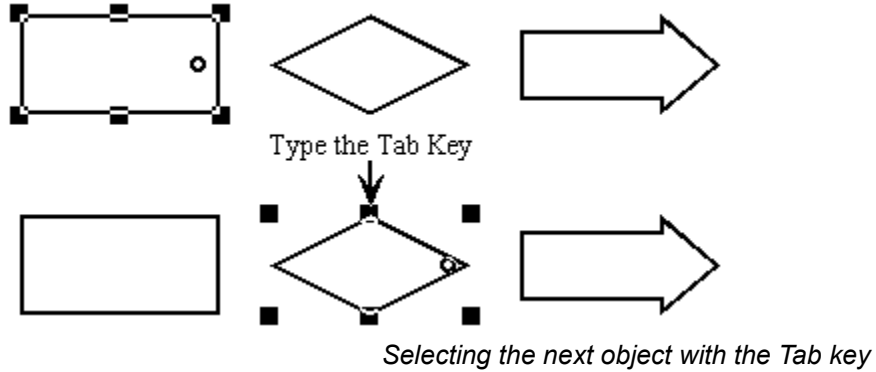

By typing the **Tab key** in this way, you can select each object in the drawing one-by-one.

Typing a **Shift-Tab** reverses direction and selects the previous object in the drawing.

See also: Text Entry and the Tab Key.

The Tab Order

The order in which objects become selected as you type the **Tab key** is called the **Tab Order**. It is the same as the front-to-back order described in [Changing the Front-to-Back Order](#).

It is also the order in which objects were created, unless you use the **Bring to Front** or **Send to Back** commands to change this order.

Text Entry and the Tab Key

If you are entering text into a shape, typing the **Tab key** selects the next shape in the tab order and opens it for text editing. **Shift-Tab** does the same in the reverse order.

You can use this feature to enter text in your shapes the way you would fill in a form: Double-click on the first shape and enter text. Then tab to the next shape, enter text, tab again and so on.

If you are entering text into a table (page 97) the **Tab key** moves you to the next text entry field in the table. Once you reach the last table field, a tab takes you to the next shape. The keyboard navigation in tables is smoothly integrated into navigation between shapes.

You can enter a *tab character* into a shape by typing **Ctrl-alt-tab**.

See also:

[Selecting with the Tab Key](#)

[SmartDraw and Forms](#)

SmartDraw and Forms

The combination of SmartDraw's table objects and the ability to tab from shape to shape make it an ideal solution for designing interactive forms that you can fill out on the screen.

Another key to designing interactive forms is the ability to prevent certain objects and fields within tables from being edited. You don't want the labels and other fixed text in a form to be edited by someone filling it out. You also want to avoid having these fixed objects selected for text editing as you tab from field to field.

In tables you can eliminate cells from the tab order by *freezing* them using the **Do Not Allow Text Editing** command under the Table menu.

You can also freeze the text in shapes using the **Text Entry Properties** command described in [Text Entry Properties](#).

Copying and Pasting

You can exchange information between SmartDraw and other programs using the *clipboard* and the standard Edit commands, **Cut**, **Copy** and **Paste**.

The clipboard is a place that Windows temporarily stores text, pictures and other data that have been *Copied* so that they can be transferred to another document or program with a *Paste* command.

When you are editing text, **Copy**, **Cut** and **Paste** act on the text in the standard Windows way. When you are not editing text entire images are transferred to and from the clipboard.

Each of these commands has a button on the toolbar you can use instead of the Edit menu.

Cut and Copy

The **Copy** command transfers all or part of the drawing to the clipboard. Its behavior depends on what is selected.

When nothing is selected, a representation of the whole drawing is copied to the clipboard (as a metafile). This drawing can then be pasted into word processors and other applications.

SmartDraw is an OLE Server. If another application supports **Object Linking and Embedding (OLE)** as a client, pasting the drawing also pastes a copy of the SmartDraw file itself into the application, so that double-clicking on the pasted drawing will open it up in SmartDraw again. This is explained in more detail in [Transferring Drawings from SmartDraw to Office](#).

When one or more shapes or lines are selected, the **Copy** command copies just those shape and lines to the clipboard. They can be pasted back into a SmartDraw drawing, or pasted (as a picture) into another program.

Cut is a combination of **Clear** and **Copy**. It first copies any selected objects to the clipboard, and then deletes them.

Paste

If the clipboard contains shapes or lines copied from SmartDraw, using **Paste** adds these to the current drawing. If the clipboard contains an image from another program it is pasted into the drawing as a *Image Object*.

See also: [Adding Objects with Paste and Paste Special](#).

Image Objects

When images from other programs are imported or pasted into SmartDraw they become **Image Objects**. These can be thought of as rectangular shapes, initially with no border, with the image inside.

A image object can be moved and arranged like any other shape. Normally when you resize them they maintain their proportions. However, if the **Shift Key** is held down while the object is resized, you can resize it to any proportion. Like other shapes, you can change a image object's sizing behavior using the **Shape Sizing** command (see [The Shape Sizing Dialog](#)), under the Shapes Menu.

When you try to type into image object, the text goes beneath the object (as a linked background text object), instead of inside.

Applying color and border changes to image objects either adds a border, or changes the colors in the image, depending on the **Change Colors** setting in the **Shape Sizing** dialog. (See [Changing the Settings for a Symbol](#).)

You can also ungroup most imported images into native SmartDraw objects using the **Ungroup** command under the Arrange menu. (See [Ungrouping Imported Images](#)).

Importing Images From Other Programs

You can import images from other programs into SmartDraw using the **Import** command under the File menu. This shows the **Import Dialog**. This is the same as the **Open Dialog** and is used to select the file to be imported.

Before you can import a file you must select the correct type using the **Files of Type** control.

SmartDraw Standard supports import of files in Windows Metafile format, and several bitmapped formats, including, BMP, PC PaintBrush (PCX), GIF, JPG and TIFF.

Professional

SmartDraw Professional imports a much wider variety of formats including:

- Encapsulated Postscript (EPS)
- AutoCAD(DXF)
- CGM
- HPGL
- PDF
- Adobe Illustrator
- CorelDraw
- MicroGrafx Draw
- Visio

Once imported, images become **Image Objects**.

Ungrouping Imported Images

With the exception of the bitmapped formats (BMP, PCX, GIF, JPG and TIFF), all image objects, whether imported or pasted into SmartDraw, are stored in WMF (Windows Metafile) format. You can ungroup these images into native SmartDraw objects using the **Ungroup** command under the Arrange menu.

When you use the **Ungroup** command on an image object the **Separate Drawing** dialog is presented.

If, when you select a imported image, the **Ungroup** command is gray and not available then your image is most likely a bitmap and cannot be ungrouped.

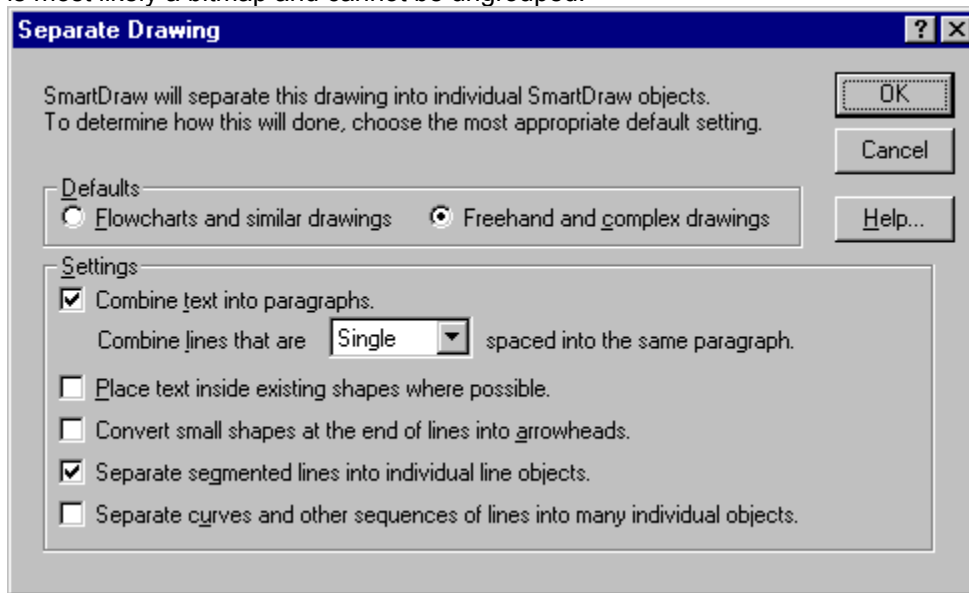

Separate Drawing Dialog

This dialog presents several options that control the way the image will be separated into SmartDraw objects.

SmartDraw performs many advanced techniques to convert crude metafile images into useful formats for flowcharting, including joining shapes to the end of lines as arrowheads, combining lines of text into paragraphs, placing text inside shapes, and joining line segments together into one segmented line. These techniques are based on empirical rules and are not always perfect. If you have imported images that do not convert well to flowcharts contact us support@smartdraw.com. We are always working to improve this process.

Defaults

Selecting the **Flowcharts** choice automatically selects the optimal combination of the separation settings for decomposing images of flowcharts. The **Freehand** choice does the same for freehand drawings.

Combine text into paragraphs

Text in imported images is separated into single line strings, where each string has one typeface. If this box is checked SmartDraw will attempt to combine these strings into one paragraph. The setting for single or double space indicates how much space SmartDraw should allow between lines before it terminates one text block and creates another.

Place text inside existing shapes

When this box is checked, the text blocks detected by SmartDraw's conversion process are placed inside any shapes detected if they lie on top of each other. SmartDraw will even detect the appropriate alignment of the text inside the shape.

Convert small shapes at the end of lines into arrowheads

With this box checked SmartDraw attempts to recognize arrowheads at the end of lines.

Separate segmented lines into individual line objects

With this box checked, SmartDraw will treat perpendicular lines that could be represented as a single segmented line as separate lines.

Separate curves and other sequences of lines into individual objects.

Freehand drawings often have many complex curves. These can be decomposed into hundreds (and sometimes thousands) of SmartDraw lines, or left combined as a single curved image. Checking this box forces their decomposition into many short straight lines. This is usually best left unchecked.

Opening Files Created with Other Flowchart Programs

SmartDraw uses its ability to decompose metafiles into useable flowcharts to convert files created with other programs into SmartDraw format.

To convert a file from Visio into SmartDraw format, just open the Visio file using the **Open** command under the file menu. Choose Visio for the file type in the **Open Dialog**. The file opens and the **Separate Drawing** dialog appears ([Ungrouping Imported Images](#)). The settings for conversion of flowcharts are already selected, but this gives you an opportunity to adjust them if your drawing does not convert well with the default settings. Press OK and the drawing is converted to native SmartDraw shapes and lines.

With other programs like Flowcharter, Flow Charting PDQ, and others, you must first save your flowchart to Windows Metafile format (WMF) using the program's own export or save command. Then you can open the WMF file with SmartDraw.

Opening native Visio files requires SmartDraw Professional. WMF files from Visio, and other flowchart programs, can be opened with SmartDraw Standard.

Exporting Drawings

Professional

You can export SmartDraw drawings in several standard Windows file formats using the **Export** command under the File menu. This presents the **Export Dialog**, which is used to specify the name of the exported file and its format. This is similar to the **Save Dialog**.

Use the **Files of Type** control to change the format of the exported file.

SmartDraw Standard supports export of files in Windows Metafile, and several bitmapped formats, including, BMP, PC PaintBrush (PCX), GIF, JPG, and TIFF.

SmartDraw Professional exports a much wider variety of formats including:

- Encapsulated Postscript (EPS)
- AutoCAD(DXF)
- CGM
- HPGL
- PDF
- Adobe Illustrator
- CorelDraw
- MicroGrafX Draw

Exporting Images to Web Pages

SmartDraw supports both of the standard image formats used on the World Wide Web: JPEG and GIF.

When exporting to a GIF you can specify a background color that will become transparent when viewed with most web browsers. You can also choose whether the exported file should be in interlaced or non-interlaced format. Interlaced images display more quickly than non-interlaced, but take longer to come into focus.

These options are specified in the **GIF Format Options Dialog**. This is displayed automatically each time a file is exported in GIF format.

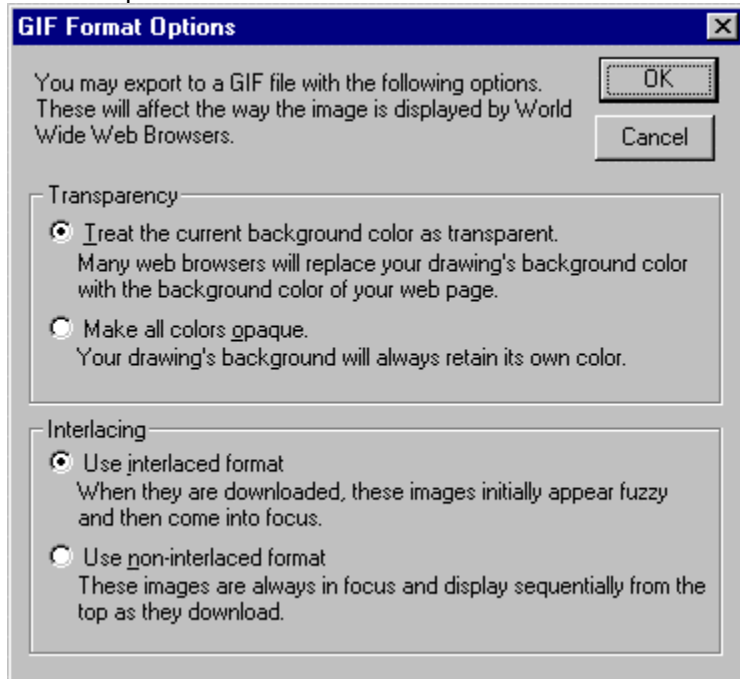

GIF Format Options Dialog

Hyperlinking to Files and Web Pages

One of the more powerful features of SmartDraw is its ability to hyperlink any shape to another SmartDraw drawing file, a web address (URL), another application's document, or even a program command line, using the **Hyperlink** commands under the Tools menu.

To create a hyperlink, you first select an object in the drawing, and then select the **Create a Link** command under the **Hyperlink** submenu. This shows the **Create a hyperlink** dialog.

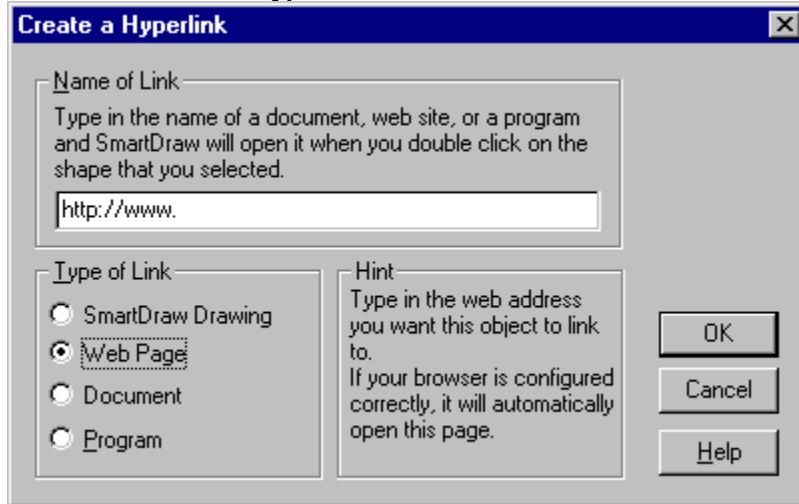

Hyperlink Dialog

Here you can choose to link another SmartDraw drawing, a web address, a document, or a program to the currently selected object.

You enter the file name, the web URL, or the program command line of the file that you want to link to. You can also use the **Browse** button to search for a particular file. This presents the standard Open dialog.

Once you select a file, or address, it is hyperlinked to the currently selected object.

From this point on, if you select this object and use the **Open Link** command (type the **F11 Key** as a short cut), the linked file, or web address, will be opened. You can break this link by selecting the object and using the **Clear Link** command.

You can only use the **Open Link** and **Create a Link** commands when a single object is selected. You can use the **Clear Link** command when more than one object is selected. The hyperlinks will be cleared from all selected objects.

Shapes and lines that have hyperlinks are shown with a special symbol that consists of a plus sign inside a small box.

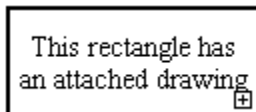

The Hyperlink Symbol

Double clicking on this symbol opens the linked file or URL.

See also: [Using Hyperlinks](#)

Using Hyperlinks

Nested Drawings

You can use hyperlinking to create hierarchical or "nested" drawings that let you *drill down* to more detail.

For example, suppose you are creating a flowchart for a process that includes one very complex step. On your summary (or high-level) flowchart, you can represent the complex step by a single shape and then hyperlink the shape to a detailed flowchart illustrating the complex process. Later, if you double-click on the hyperlinked symbol in the summary chart, the detailed chart represented by the shape opens up.

Web Site Mapping

The ability to hyperlink a shape to a web page URL makes SmartDraw a very useful tool for drawing a flowchart that documents a web site. Each page may be represented by a symbol that is actually hyperlinked to the page itself.

Notes and Background Information

You can attach a page or more of notes to any shape in a drawing by hyperlinking it to a word-processing document. You can also attach a help file or a web address. For example, in a network diagram you can attach the web address of the manufacturer of the piece of hardware represented by a symbol.

While SmartDraw can exchange drawings with most Windows programs, it is designed to work especially closely with Microsoft Office.

Transferring Drawings from SmartDraw to Office.

Copy and Paste

The easiest way to transfer drawings you create in SmartDraw to **Microsoft Word**, (and the other Office programs) is to simply **copy** all or part of the drawing in SmartDraw and then **paste** it into **Word**.

OLE (Object Linking and Embedding)

Because Word is an OLE Client and SmartDraw is an OLE Server, Word stores *all* of the SmartDraw drawing information in its document when you paste, not just the picture you see. This is called **Embedding**. A copy of your SmartDraw drawing is *embedded* in the Word document.

If you double-click on the SmartDraw drawing in Word it will re-open in SmartDraw and you can to edit it.

Another way of transferring a SmartDraw drawing to Word is to paste an *OLE Link* using Word's **Paste Special** command (page 171). If you choose to paste a link, using this dialog, the picture you see is transferred to Word along with the name of the SmartDraw file it came from.

If you double-click on the *linked* SmartDraw drawing in Word it opens the original SmartDraw file allowing you to edit it, just as with an embedded drawing. OLE Linking is useful if you want just *one* copy of your drawing to be shared between several documents. When you *embed* a drawing, changing the embedded copy does not change any other copy. When you paste an OLE *link*, changing the one linked drawing changes all the linked copies of that same drawing.

Drag and Drop

You can also drag selected parts of a drawing from SmartDraw into Word and other office programs. Unless you hold down the **Ctrl key** while you do this, the selection will be deleted from the drawing after it is transferred to Word. This conforms the standard Windows interface for drag and drop between applications.

See also:

[Inserting a SmartDraw Object into Word](#)

[Transferring Objects from Office to SmartDraw](#)

[Microsoft Office Companion](#)

Inserting a SmartDraw Object into Word

Professional

You need not actually run SmartDraw at all in order to insert a SmartDraw drawing into a Word document. Word has an **Object** command on its **Insert** menu. You can use this command to insert a SmartDraw drawing directly into your document. You can insert a new drawing or an existing one. The details of this are described in [Inserting Objects](#) and in Word's own documentation.

When you insert a new document, the last type you picked from the **New Drawing** dialog is created by default.

Transferring Objects from Office to SmartDraw

In addition to being an OLE server, the Professional edition of SmartDraw is also an **OLE Client**, like Word, PowerPoint and Excel.

This means that when you paste images from other programs that are OLE servers into SmartDraw, they become embedded or linked OLE objects that can be re-opened and edited by their parent programs.

For example, if you paste a graph from Excel into a SmartDraw drawing, both the image of the graph and the underlying Excel file structure are stored in the embedded drawings. Double clicking on the graph in SmartDraw opens it again in Excel, for editing.

The images you paste from Office behave just like library symbols in SmartDraw. You can link lines to them, flip them, rotate them, and resize them. They also have the very special property that you can open them in Office, simply by double clicking on them in SmartDraw, and modify them.

Perhaps most important of all, you can add OLE objects to libraries, and they retain their OLE object nature. SmartDraw Professional supports libraries not only of symbols, but also of *live objects* that can be opened in other applications! This is the basis for the [Office Companion](#).

See also:

[Adding Objects with Paste and Paste Special](#)

[Inserting Objects](#)

[Editing OLE Objects](#)

Microsoft Office Companion

With SmartDraw Professional and Microsoft Office you can add real graphs, bitmaps, equations, spreadsheets and all of the Office clipart to your SmartDraw drawings with just one click.

If Microsoft Office is installed on your computer, SmartDraw Professional shows a special set of toolbar buttons on the right end of the top toolbar.



Office Companion Toolbar

If you click on one of these buttons you can add any of the following objects your drawing.

- Bitmap (Paint)
- Graph (MS Graph)
- WordArt (MS WordArt)
- Clipart (Clipart Gallery)
- Equation (MS Equation)
- Spreadsheet (Excel)
- Word processing document (Word)

If any of these applications are not installed on your system, their buttons do not appear.

When you click on the **Bitmap** button the **Windows Paint** application is launched. The image your draw will appear in your drawing when you close Paint. A similar thing occurs when you press the **Equation**, **Spreadsheet** and **Word Processor** button.

Pressing the **Clipart** button shows the **Office Clipart Gallery**. By using this button the thousands of images that are included with Office become SmartDraw symbols too.

Pressing the **Graph** or **WordArt** buttons shows the **Gallery Dialog**. Here you can choose from a collection of symbol libraries containing pre-formatted Graphs or WordArt examples.

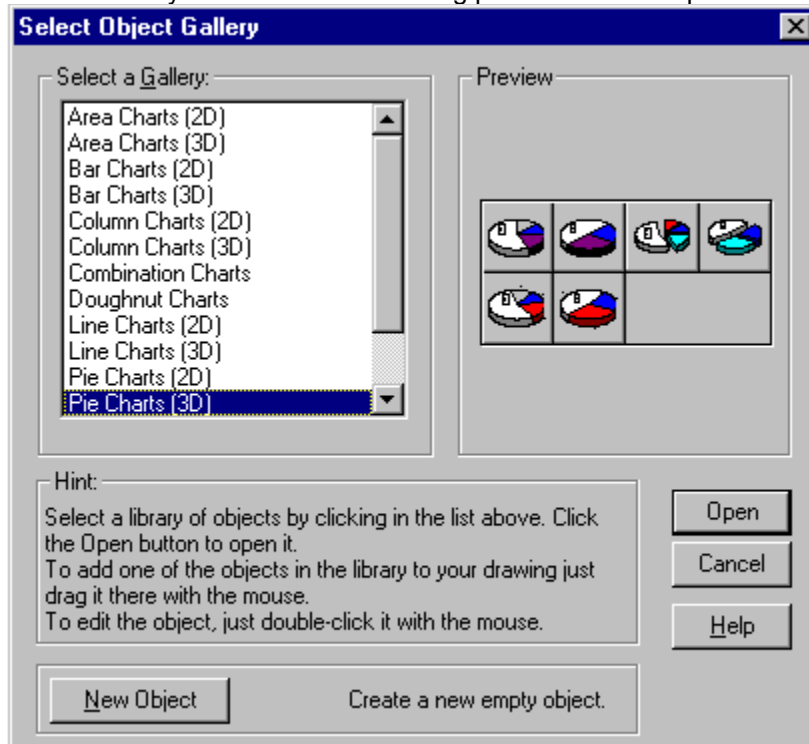

Object Gallery Dialog

Selecting a library from the list displays its preview on the right. If you open one of these libraries, you can drag one of the sample objects into your drawing and then open it by double clicking or using the object menu commands (page 173).

Adding Objects with Paste and Paste Special

In addition to using the [Office Companion](#) toolbar buttons, you can also **Paste** an object from Office, or other OLE Server applications, into the Professional Edition of SmartDraw. When you do this, SmartDraw makes its own copy of the application file and stores it in the drawing. This is called *embedding*.

When you paste using the **Paste Special** command you can choose between several different ways of pasting. The command shows the **Paste Special Dialog**.

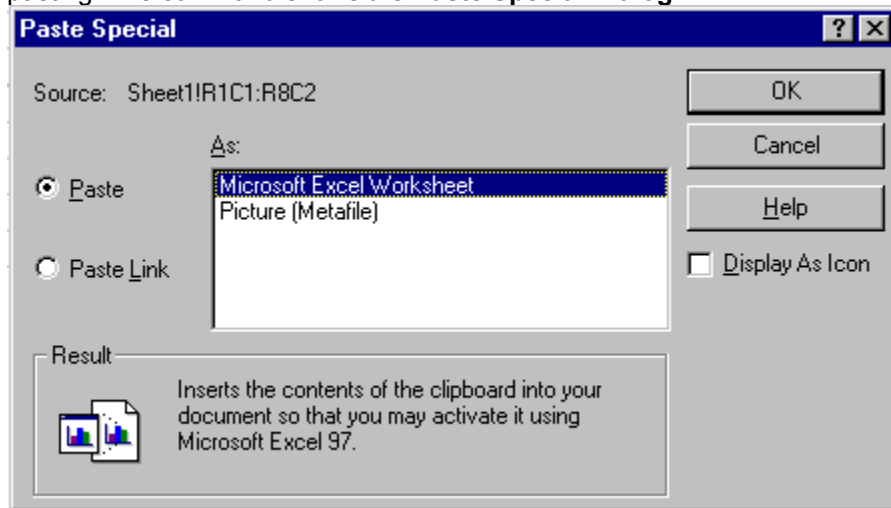

Paste Special Dialog

The dialog shows a list of formats. When you select the first format at the top of the list, depending on the program you copied from, you may be offered the choice of **Paste** or **Paste Link**. Pasting a **Link** pastes the picture plus the name of the file it came from. Then, whenever you change the contents of this linked file, SmartDraw will update the picture to the newest version.

Choosing the second item in the list (Picture) does not give you the choice of **Paste Link** and normal pasting just transfers an image into SmartDraw without the underlying data. If you paste just an image and then change the original file you copied from, you'll need to paste it into SmartDraw again to get the revised image.

See also:

[Inserting Objects](#)

[Editing OLE Objects](#)

[Managing Links](#)

Inserting Objects

You can also add OLE objects to SmartDraw with the **Insert Object** command under the Edit menu. This shows the **Insert Object Dialog**.

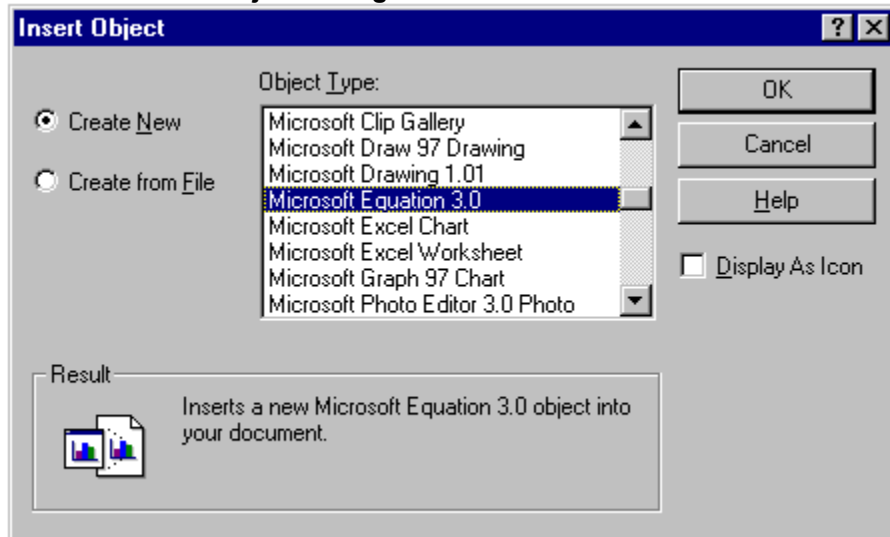

Insert Object Dialog (Create New)

When the **Create New** radio button is selected, the list shows all of the object types installed on your system. To create a new object just select one of the items in the list and press OK.

When the **Create from File** button is selected the dialog changes to the form shown below

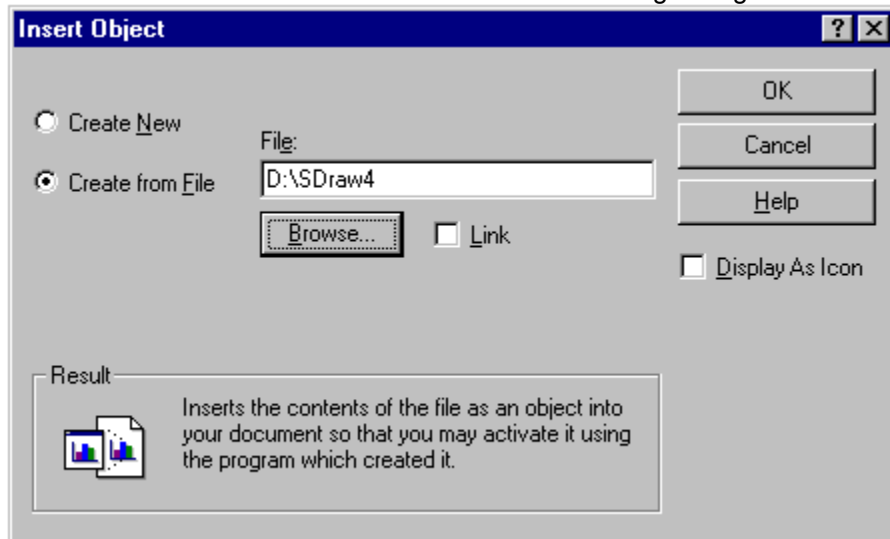

Insert Object Dialog (Create from File)

This allows you to pick an existing file and create an embedded or linked object from it.

See also:

[Transferring Objects from Office to SmartDraw](#)

[Microsoft Office Companion](#)

[Adding Objects with Paste and Paste Special](#)

[Editing OLE Objects](#)

Editing OLE Objects

When an OLE object is selected, the bottom item of the SmartDraw Edit menu changes to a submenu showing the name of the object.

You can use the commands on this menu to Open the object for editing. You can also double-click on the object itself to open it for editing.

Managing Links

When an OLE Linked object is selected, the **Links** command under the Edit menu presents the **Links Dialog**. You can use this to manage links in your document.

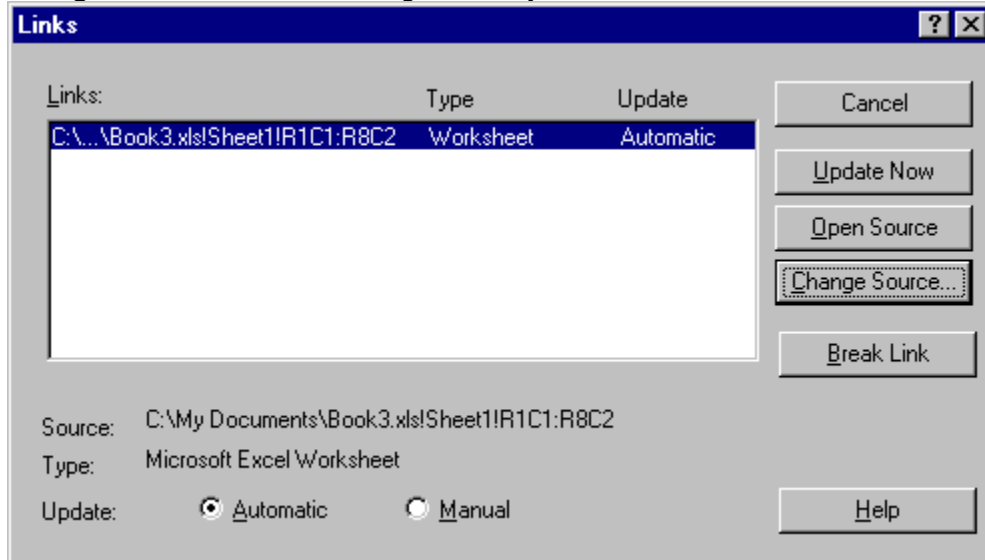

The Links Dialog

The list shows all of the linked OLE objects in your drawing. You can change the parameters of the selected object in the list using the buttons on the right.

Open Source opens the file associated with the link. **Change Source** lets you fix a link that has been broken because the file moved.

Update Now causes SmartDraw to get the current image from the linked file. **Break Link** breaks the OLE link, making the object a simple image object that no longer updates.

Spelling Correction

Professional

The Professional version of SmartDraw can check the spelling of the text you enter while you are typing. If you misspell a word, it is underlined with a wavy red line.

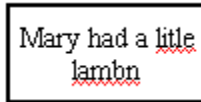

Misspelled words are underlined with red wavy lines.

Right clicking (clicking with the right mouse button) on the misspelled word shows a menu with alternative spellings and other commands.

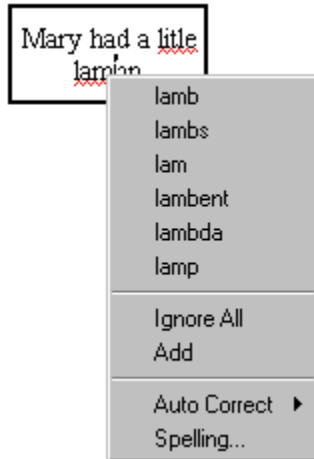

Right-clicking on a misspelled word.

If you select one of the alternative spellings, the word is replaced with this selection. The other commands:

- **Ignore All.** Ignores the word for this session.
- **Add.** Adds the word to your user dictionary, so that it is considered correct in all future sessions.
- **Auto Correct.** Adds the word to your user dictionary along with the misspelling, so that if you use that misspelling again, SmartDraw will correct it for you automatically.
- **Spelling.** This shows the **Check Spelling** dialog.

To prevent SmartDraw from checking your spelling as you type, turn off the **Check Spelling While You Type** command under the Tools menu. You can use the same command to turn it back on again. On slower computers, turning off spelling correction while you type will speed up text editing.

See also:

[The Check-Spelling Dialog](#)

[Selecting a Spelling Language](#)

[The Dictionary Dialog](#)

The Check-Spelling Dialog

You can check the spelling of an entire document (or just the selected text or shapes) interactively using the **Check-Spelling Dialog**.

When you use this command to check spelling interactively, either the selected range of text, or the selected object(s), are checked first. You are then given the opportunity to continue correct spelling in the rest of the document.



The Check-Spelling Dialog

The Check Spelling Dialog has the following controls

Add

This causes the reported word to be added to the dictionary currently selected in the **Add Words To** list. Use the **Add** button if a correctly spelled word you use often is reported as a misspelling (e.g., your family name). If the word is not used frequently, you may want to select the **Ignore** or **Ignore All** buttons instead.

Add Words To

This indicates which user dictionary words will be added to when you select the **Add** button. The **Add Words To** list shows all user dictionaries currently open. You can open or close other dictionaries via the **Dictionaries** dialog, which is accessible by selecting the **Dictionaries** button.

Cancel

Stops the current spell-checking operation.

Change

Causes the reported word to be replaced with the word in the **Change To** box. Only this occurrence of the reported word is replaced. If you want this and all following occurrences of the word replaced, select the **Change All** button. If the **Change To** box is empty, such as when a repeated word is reported, the **Change** button changes to **Delete**.

Change All

Causes this and all following occurrences of the reported word to be replaced with the word in the **Change To** box. If you want only this occurrence of the word to be replaced, use the **Change** button. If the reported word is one you frequently misspell, you might consider adding it to a user dictionary via the **Dictionaries** dialog. You can display the **Dictionaries** dialog by selecting the **Dictionaries** button.

Change To

Contains a word that will replace a misspelled word when you select the **Change** or **Change All** buttons. You can enter a word in the **Change To** box by typing, or you can select one of the suggested replacements from the **Suggestions** list.

Consider Changing

Contains a word that may be misspelled or otherwise incorrect, and is presented with a candidate replacement word. You can change the word by selecting the **Change** button, or skip it by selecting the **Ignore** button. Note that the label of this box changes to "**Not in dictionary**" when a misspelled word is detected.

Dictionaries

Causes the Dictionaries dialog to be displayed. You can use the Dictionaries dialog to open or close user dictionaries, and to edit the contents of user dictionaries.

Ignore

Causes this occurrence of a misspelled word to be skipped. If the same misspelled word appears later, it will be reported.

Ignore All

Causes this and all further occurrences of this misspelled word to be skipped. You might use this button if the word reported as a misspelling is actually spelled correctly. If the word is one you use frequently, you may wish add it to your dictionary by selecting the **Add** button.

Lock Pos

Locks the position of the Check-Spelling dialog in place. Normally the Check-Spelling dialog attempts to position itself to avoid the window containing the text being checked. When the **Lock** check-box is checked, the Check-Spelling dialog will always appear at the last place you positioned it.

Not in dictionary

Indicates that a misspelled word was detected. The word is considered misspelled because it could not be located in any open dictionaries. Note that the label of this box changes to "**Consider changing**" when a word and a suggested replacement are displayed.

Options

Causes the **Options** dialog to be displayed. You can use the Options dialog to set spelling-checker options.

Suggest

Search more thoroughly for suggested replacements for the current misspelled word. Each time you press the **Suggest** button, a "deeper" search is made. The **Suggest** button is disabled once all possible suggestions have been located.

Suggestions

Contains a list of suggested replacements for the misspelled word reported as misspelled. This list is filled in automatically when a misspelled word is detected. Subsequent presses of the **Suggest** button may yield more suggestions. A word selected in this list will be automatically copied to the **Change To** box, where it can be substituted for the misspelled word by pressing the **Change** button.

Undo button

Removes the last change made.

Selecting a Spelling Language

The **Spelling Language** submenu, under the Tools menu, lets you switch languages with a single menu command. Each language supported is shown on the submenu. The currently selected one is shown with a check mark. The language selection applies to SmartDraw as a whole, not just the document that you are working on. SmartDraw supports the following languages.

- American English
- British English
- Brazilian Portuguese
- Danish
- Dutch
- Finnish
- French
- German
- Norwegian
- Italian
- Spanish
- Swedish

These dictionaries are available on the SmartDraw CD, or via download from <http://www.smartdraw.com/dictionaries.htm>.

Dictionary Organization

The language dictionaries are stored in the **Spelling** folder inside the SmartDraw program folder. Each language has its own folder inside the Spelling folder. All users on a network share these dictionaries.

The custom dictionaries that users edit and add to are stored in a folder inside their **Windows** folder called **SmartDraw**. Each user on a network has his or her own custom dictionaries.

The Dictionary Dialog

Pressing the **Dictionaries** button in the **Check-Spelling** dialog, or using the **Spelling Dictionaries** command under the Tools menu, opens the **Dictionary Dialog**. This allows you to manage your own custom dictionaries, where your own private words (like your name, special acronyms, etc.) are stored.

The **Dictionary Dialog** allows you to open and close user dictionaries, and to edit the contents of an open user dictionary. The contents of dictionaries are saved in disk files. You can open some or all of your user dictionary files at any time. Only open dictionaries are consulted during a spell-checking operation.

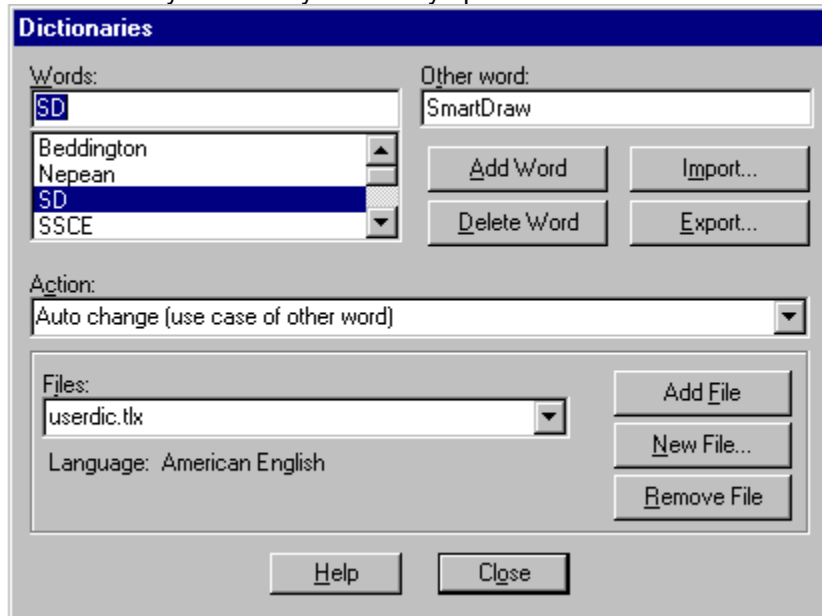

The Dictionaries Dialog

The Dictionary Dialog has the following controls:

Words

This contains the list of words in the currently selected user dictionary, as well as the currently selected word.

Other Word

This contains an alternate word associated with the currently selected word. The other word is used in the **Auto change** and **Conditionally change** actions to supply a replacement word. You can enter more than one word in the **Other Word** box, but the total length should be limited to 63 characters.

Action

The action tells the spelling checker what to do when it finds a word in the dictionary. The following actions can be selected:

Auto change (use case of checked word)

This action allows you to automatically replace one word with another. For example, if you often type **recieve** instead of **receive**, you might enter the word **recieve** with **receive** as the other word and **Auto change (use case of checked word)** as the action. The spelling checker will then automatically correct **recieve** wherever it appears. If **recieve** was capitalized (**Recieve**) the spelling checker would automatically replace it with **Receive**. Note that the replacement is made automatically only if the **Auto Change** option is enabled (see the **Spelling Options Dialog** for information on the **Auto Change** option).

Auto change (use case of other word)

This action allows you to automatically replace one word with another, without considering the case of the replaced word. This action is useful for automatically expanding abbreviations. For example, you could enter the word **TBD** with **to be determined** as the other word and **Auto change (use case of other word)** as the action. The spelling checker will automatically replace **TBD** with **to be determined** wherever it appears.

Conditionally change (use case of checked word)

This action is the same as **Auto change (use case of checked word)** above, except that the replacement is only suggested by the **Check-Spelling** dialog. It does not happen automatically.

Conditionally change (use case of other word)

This too is like **Auto change (use case of other word)** but is only suggested by the **Check-Spelling** dialog.

Exclude (treat as misspelled)

This action tells the spelling checker that the word is misspelled, even if it is listed in another dictionary. Words marked with this action will never be offered as suggestions for misspelled words, and they will be reported as misspellings when they are encountered by the spelling checker. Note that the spelling checker looks up words in user dictionaries in the order in which the dictionary files appear in the Files list. If you want to exclude a word, make sure it doesn't appear in a previous user dictionary.

Ignore (skip)

This action tells the spelling checker that the word is spelled correctly, and can be skipped over. This is the most common action.

Add Word

This causes the word entered in the edit area of the **Words** list to be added to the currently selected dictionary. The currently selected action and other word are associated with the word. You can use the **Add Word** button to change the action or other word associated with a word. Note that the **Add Word** button is enabled only when a new word is typed in the edit area of the **Words** list. The words you add may contain virtually any character, but only words which contain embedded periods should have trailing periods (e.g., U.S.A. is OK, but USA. is not).

Delete Word

This causes the word appearing in the edit area of the **Words** list to be removed from the currently selected dictionary. The associated *action* and other word are also removed.

Files

This contains the list of open dictionary files. When you select a dictionary file from the list, its contents are displayed in the **Words** list.

Add File

This opens a user dictionary file. When you select the **Add File** button, a dialog appears which you can use to select the dictionary file to open. The set of open dictionary files is remembered, so once you add a dictionary file you don't need to add it again. If you need to create a new user dictionary, use the **New** button. You can open other applications' user dictionary files, including those of Microsoft Office.

Your Office user dictionary is usually called **custom.dic**. Search for this file and add it to the file list and you can share a common list of your personal words with SmartDraw.

Remove File

This closes the currently selected dictionary file. Closed dictionaries are not checked during a spelling check. Although the file is closed, it is not deleted. Closed dictionary files can be later reopened using the

Add File button.

New

This creates a new user dictionary file. When you select the **New** button, a dialog appears which you can use to specify attributes of the new dictionary.

Export

This saves the contents of the currently selected dictionary to a text file. When you select the **Export** button, a dialog appears which you can use to select the name of the text file to which words in the dictionary will be exported. The words are written to the file one per line.

Import

This adds the words contained within a text file to the currently selected dictionary. When you select the **Import** button, a dialog appears which you can use to select the text file to be imported. Each word in the selected file is loaded into the dictionary.

Language

This displays the language (e.g., English, or French, etc.) of the words in the currently selected dictionary.

New Dictionary Dialog

You can use the **New Dictionary Dialog** to specify the attributes of a new user dictionary.

File Name

Contains the name of the disk file used to hold the new dictionary's contents. You can enter a name here or use the Browse button to display a dialog showing the names of other dictionary files.

Browse

Displays a dialog which shows the names of other user dictionary files. You can use the dialog to view the names of existing dictionary files, and to enter the name of the new dictionary file.

Language

Specifies the language (e.g., French, English) of the words the new user dictionary will contain. If the language you want to use is not listed, select "Other."

OK

Closes the **New Dictionary Dialog** and creates the new dictionary.

Cancel

Closes the New Dictionary Dialog without creating a new dictionary.

Spelling Options

The **Spelling Options** command opens the **Spelling Options Dialog**. This lets you specify several options that affect the way the spelling checker operates.

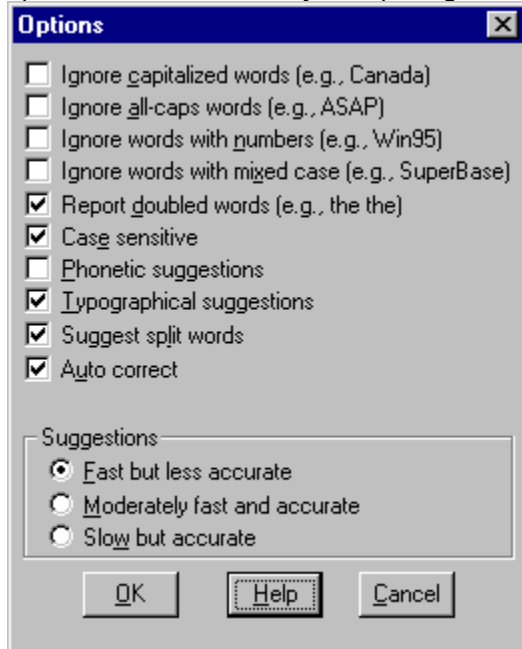

Spelling Options Dialog

Ignore Capitalized Words

When enabled, any words beginning with a capital letter are ignored (i.e., are skipped over without being checked). You might enable this option if the text being checked contains many proper names.

Ignore All-Caps Words

When enabled, any words consisting entirely of capital letters are ignored. You might enable this option if the text being checked contains many acronyms.

Ignore Words with Numbers

When enabled, any words containing embedded digits are ignored. Examples of such words include **Win95** and **Q4**.

Ignore Words with Mixed Case

When enabled, any words containing an unusual mixture of upper- and lower-case letters are ignored. Examples of such words include **SmartDraw** and **CapsLock**.

Report Doubled Words

When enabled, any word appearing twice in a row is reported via the **Check Spelling Dialog**.

Case Sensitive

When enabled, a distinction is made between capitalized and non-capitalized words. For example, **canada** is considered different from **Canada**, so **canada** would be reported as a misspelling. When the

option is disabled, **canada** and **Canada** are considered identical. Note that the performance of the spelling checker will be reduced if this option is disabled.

Phonetic Suggestions

When enabled, suggestions are made on the basis of phonetic (sounds-like) similarity to the misspelled word. This option tends to improve suggestions for badly misspelled words. Enabling this option will increase the time required to locate suggestions. Note that either this option or the **Typographical Suggestions** option must be enabled or no suggestions will be offered.

Typographical Suggestions

When enabled, suggestions are made on the basis of typographical (looks-like) similarity to the misspelled word. This option is appropriate for people who are generally good spellers. Note that either this option or the **Phonetic Suggestions** option must be enabled or no suggestions will be offered.

Suggest Split Word

When enabled, two separate words will be suggested as a replacement for a misspelling containing two joined words. For example, **is the** would be suggested as a replacement for **isthe**.

Auto Correct

When enabled, words marked with **Auto Change** actions will automatically be changed to their specified replacements. When disabled, you will be prompted before the words are changed.

Suggestions

Determines the speed and accuracy of the initial search for suggested replacements for misspelled words. When a misspelled word is detected, a search is automatically made for suggestions. This option controls the speed and accuracy of this automatic search. Pressing the **Suggest** button in the **Check-Spelling** dialog causes an increasingly more accurate (but slower) search for suggestions, with each successive click.

Find and Replace

Professional

Using the Professional version of SmartDraw, you can find and replace any word in your drawing.

The **Find** command, under the Edit menu, shows the **Find and Replace Dialog**.

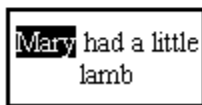
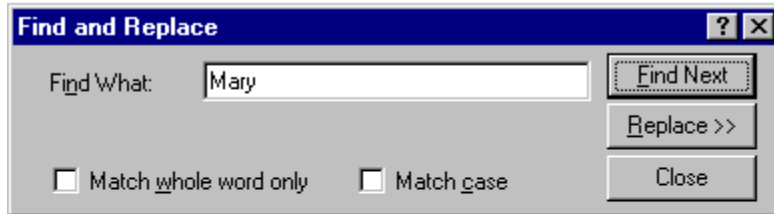

Find and Replace Dialog

You can enter any *target string* into this dialog. If you press the **Find Next** button, SmartDraw will search for a match. Once a match is found, it is highlighted and scrolled into view. Pressing **Find Next** again, finds the next occurrence.

Initially only the selected range is searched. This is either the selected range of text within a shape, or the selected shape(s) or table. Once all selected instances of the target word have been examined, you are then given an opportunity to search the remainder of the drawing.

Normally SmartDraw searches for the target string without regard to upper or lower case, and it will report matches that are not whole words. For example, if you search for **mary** it will find **Maryanne**. You can change this behavior by checking the checkboxes in the dialog.

Match case causes SmartDraw to find matches only when the case of the characters in the drawing also match the target.

Match whole word only causes SmartDraw to ignore matches when the target appears as part of another word.

Replacing Words

If you click on the **Replace** button in the Find and Replace Dialog, or select the Replace command under the Edit Menu, the dialog opens out to its expanded form.

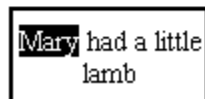
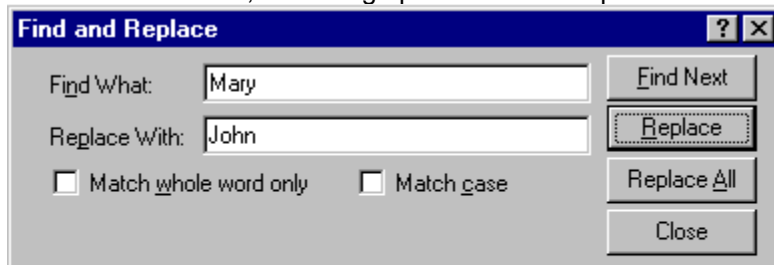

Expanded Find and Replace Dialog

If the target string is highlighted in a shape, pressing the **Replace** button will replace the target with the *replacement string* and then go on to find the next match. Pressing **Replace** again, replaces the next match and so on.

You can replace all instances (initially in your selected range and then in the entire document) automatically by pressing the **Replace All** button.

"Find Next" Menu Command

After you close the dialog, your target and replacement strings (and checkbox settings) are remembered (even between sessions). You can find the next instance of the current target string at any time without showing the **Find and Replace Dialog**, by using the **Find Next** command under the Edit Menu.

The shortcut to the **Find Next** command is the **F3 key**. Holding the **Shift key** down and typing **F3**, finds the previous match. The search order is the same as the tabbing order in the drawing (See [The Tab Order](#)).

New Drawing Buttons

The buttons shown on the New Drawing dialog are actually read from the SmartDraw program folder at run time. This means that you can add your own drawing types and templates, and create your own custom buttons for them.

Each drawing type has its own folder inside the **Templates** folder, which is inside the SmartDraw program folder. For example, the **Flowcharts** drawing type has a folder **Templates/Flowcharts**.

A drawing type folder must contain the following files to show up as a button on the **New Drawing** dialog:

- An **icon.bmp** file
- An **ord** file
- At least one template file

The **icon.bmp** file is a 60x60 bitmapped image in **BMP** format that will show up as the picture on the button for the new category. If you don't put this file into your folder, SmartDraw will make one with a simple text label as the image.

If you want part of your icon to be the color of the button, use the gray (0x0c0c0c) as a transparent color.

The empty file **500.ord** will give your new drawing type a weight of 500 when SmartDraw sorts the buttons in the dialog from the top left. Changing the number in front of the **ord** extension lets you choose the position of the button in the dialog. This applies to existing drawing types too!

There must be at least one SmartDraw template in the folder. If your template is called **EMPTY.SDT** it will be opened when you press **OK** at the **New Drawing** dialog. It is the "default" template for this drawing type.

If you have no other templates in the folder, then the **View Templates** button in the dialog will be gray and unavailable. If you have other templates but no **EMPTY.SDT** then the **OK** button will be unavailable and you will be forced to select a template.

Creating SmartDraw Templates

Creating your own **SmartDraw Template** files is easy. A template file is exactly the same as a regular SmartDraw file, except that you save it with file extension of SDT instead of the normal SDR. Make sure you actually select the *SmartDraw Templates* choice on the **Save Dialog**'s list of file types. This will ensure that your template has a preview to show in the **Template Dialog** ([Selecting a Template](#)).

Unless you save a new template file into one of the existing drawing-type folders within the **Templates** folder, it will not show in the Template dialog.

SmartDraw comes with a broad selection of templates for many drawing types. These are displayed in the **Template Dialog** whenever you press the View Templates button in the **New Drawing** dialog.

When you select a template from the Template dialog, SmartDraw creates a new drawing that is a copy of the template. Changes made to this copy do not affect the original template.

See also: [Designing Templates](#)

Designing Templates

Templates are used both to store a desired set of default settings for new documents and to store a sample drawing.

These are some of the defaults that are saved with a template:

- Snap-to-grid alignment
- Line and Shape linking settings
- Document toolbar
- Colors and shadows
- Line and border thickness
- Font
- Rulers and their scale
- Page orientation and size
- Zoom level

The first two of these are perhaps the most important because they have a large impact and have very different settings for different kinds of drawing.

Snap to Center vs. Snap to Top-Left

Shapes can either snap to the grid so that their centers align with the grid lines, or so that their top and left edges snap to the grid lines..

If your template is to be used to create drawings that make use of the linking of lines to shapes, such as flowcharts, organization charts, circuit diagrams, network diagrams and engineering diagrams, then you should choose **Snap to Center**. This parameter is set in the **Define Rulers and Grid Dialog** ([Setting the Ruler Scale](#)).

If, on the other hand, your template will be used to make drawings where shapes are placed at exact locations so that their edges line up, you should choose **Snap to Top-Left**. Examples of diagrams of this kind include floor plans, forms, timelines etc.

Line and Shape Linking

The settings of **Allow Lines to Link** and **Allow Shapes to Link** under the Arrange Menu are also stored with a template.

For diagrams in which lines are typically linked to shapes (like flowcharts) line linking should be turned on and shape linking turned off.

For diagrams that require alignment of shapes, like floor plans, both should be off.

There are some drawing types that make use of shape linking. These include block diagrams and chemical symbols. Both of these types use shape linking to align and connect library symbols.

Document Toolbar

If a **Document Toolbar** is attached to your drawing when you save it as a template, it is stored as part of the template definition. It will reopen as part of the new drawing created with that template. You can use this to automatically open the most useful symbol library for your drawing type as a document toolbar.

Fonts and other Settings

The choices for default fonts, colors etc., are mainly a matter of taste.

You set these defaults by applying them to a shape and a line in the drawing you are using to design your

template. The changes you make to the shape and line also set the default settings for new objects. Before you save the template, you can delete the sample shape and line you used to set the defaults and the defaults will still remain in force.

As an example, to change the default font for a template first add a shape and type "hello" inside it. Select the shape so that it shows selection handles. Use the Font command under the Text menu to change the font, size and style of the text in the shape.

Now delete the shape by typing the backspace key (while it is still selected). This drawing, saved as a template, will re-open with the default font, size and style set to the values you selected in the Font dialog.

Settings for Empty Drawings

If you want to change the default font or color scheme for the new drawings you create using **Create New Document** dialog, simply replace the **EMPTY.SDT** template in the drawing type folder ([New Drawing Buttons](#)) with one that has your desired defaults already set.

IMPORTANT: *Make sure that the template you replace EMPTY.SDT with was created from the same drawing-type.*

Skipping the New Drawing Dialog

You can change a setting in the Options Dialog to skip showing the New Drawing dialog each time you want to create a new drawing, and instead automatically open a copy of the template **SMRTDRAW.SDT**.

To use this feature, create a drawing with defaults that you want for all new drawings. Delete any objects and save it as a template, in the *same directory as the SmartDraw program*, with the name **SMRTDRAW.SDT**.

Next, use the **Options** command under the Tools menu and click on the **Copy the SMRTDRAW.SDT template** radio button.

Now each time you create a new drawing the **New Drawing** dialog will not be shown. Instead a drawing with the characteristics of the **SMRTDRAW.SDT** file that you saved will be opened automatically.

The Options Dialog

The **Options** command under the Tools menu, shows the SmartDraw **Options Dialog**.

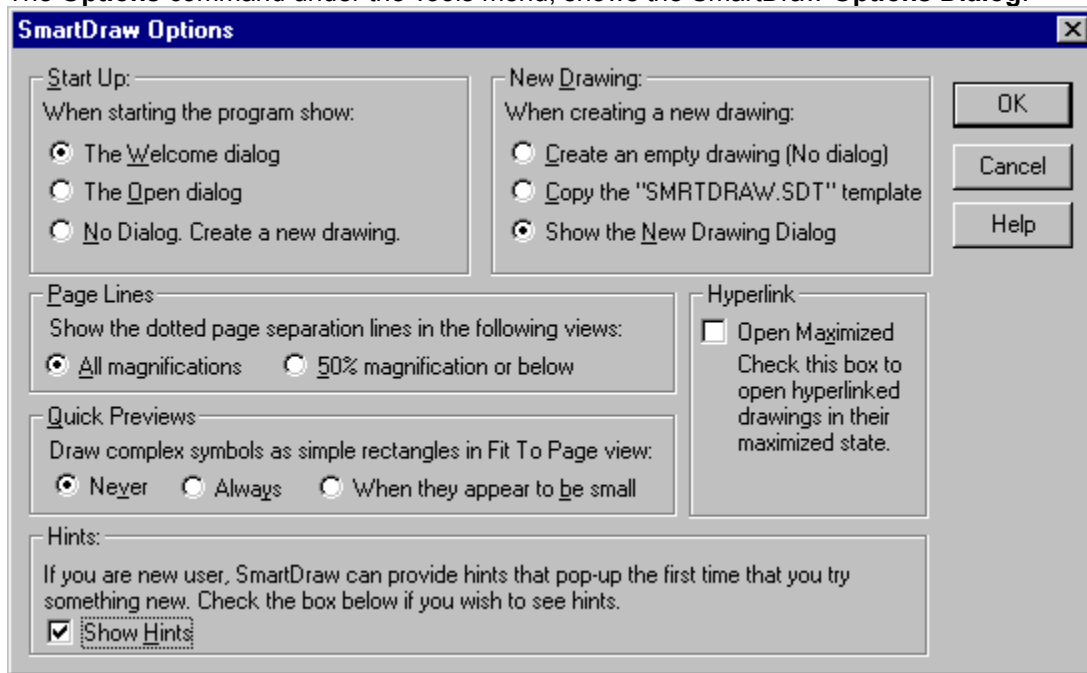

The SmartDraw Options Dialog

This controls the way the program behaves when starting up, when a new drawing is created, and other options.

Start Up

When SmartDraw first starts up it can either show the Welcome dialog , create a new empty drawing, or show the Open dialog , depending on which radio button is selected.

New Drawing

When a new drawing is created either using the **New** command, or automatically when the program starts up, SmartDraw can either present the **New Drawing** dialog, automatically create one with the flowchart defaults, or it can look for the template file **SMRTDRAW.SDT** and attempt to open it as a new untitled drawing.

You can use the **SMRTDRAW.SDT** feature to control the default colors, styles and other drawing parameters for newly created drawings ([Skipping the New Drawing Dialog](#)).

Page Lines

At magnifications of 50% or below, the boundaries of the currently chosen page size are shown as dotted lines. Selecting the **All Magnifications** radio button causes these lines to be displayed in all magnifications.

Quick Previews

For large drawings that have lots of complex symbols previewing in the **Fit to Window** view can sometimes be time consuming. In these cases, you can increase redraw speed by choosing to draw only a rectangular frame instead of the whole image in this view, either always, or only when a symbol is small.

Hints

SmartDraw will display hints for beginning users if this box is checked. These are dialogs that pop-up automatically when you try to use certain features of the program for the first time. They attempt to explain what you are about to do and provide a direct route to more detailed help.

Each hint will only appear once in each SmartDraw session. Hints can be switched off from any Hint dialog. We recommend that you leave the Hints switched on the first few times you use the program.

Changing the Program Toolbar

The buttons on the **Toolbar** that show shapes can be changed to show any of the 24 standard shapes. You can do this either by double-clicking on the shape button that you wish to change, or by clicking on it once and then selecting the **Toolbar** command under the Tools menu. Both of these actions present the **Edit Toolbar Location Dialog**.

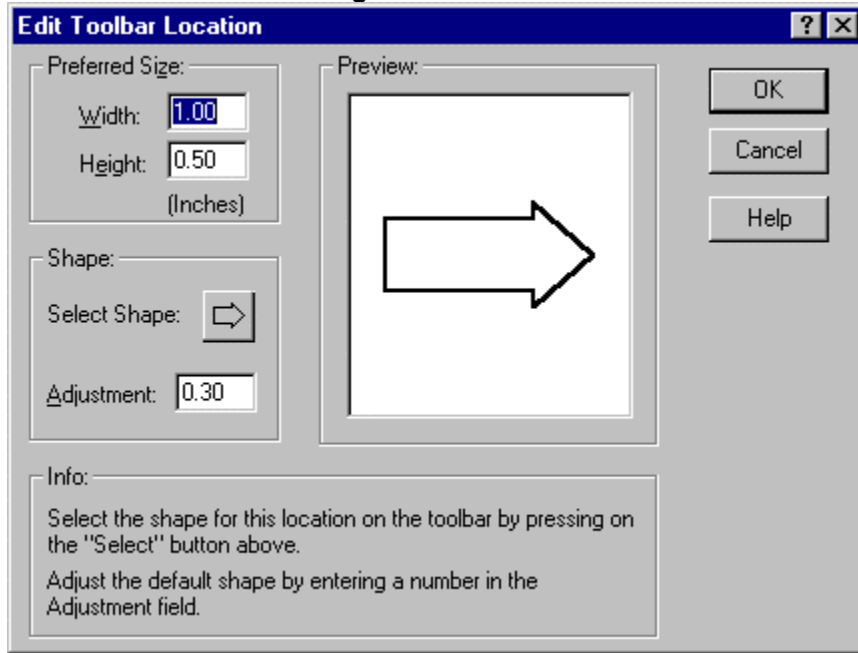

Edit Toolbar Location Dialog

This dialog can also be used to set the default size of the shape when it is added to the drawing using a drag and drop operation, as well as setting the "shape" parameter itself.

Select Shape

A button shows the shape currently selected for this toolbar location. Pressing the button presents a menu of standard shapes. Selecting one changes the assignment of the button to the selected shape.

Preferred Size

The width and height fields control the size of this shape when a copy is added to the drawing using a drag and drop operation. For circles, and other shapes that can only be sized proportionately, changing one value changes the other, so as to maintain the same proportions.

Adjustment

The shape adjustment applies only to certain shapes and adjusts their outline. For example, the degree of roundness for rounded rectangles, the proportion of angled arrows, and so on.

The **Adjustment** field is only visible if the shape selected for the button may be distorted in some way. The parameter value represents a proportion of the width or height of the shape and is usually limited to a range of 0.1 to 0.4, or sometimes less. The effect of the change can be seen in the preview window if you click on it or click in another field.

Changing these parameters has no effect on any existing shapes in your drawing. They affect only new shapes that you add later. The outlines of existing shapes can be adjusted by clicking on their adjustment handles, as described in *Adjusting Shape Outlines* [Adjusting Shape Outlines](#).

Changing the shape assigned to the button will change the parameter to its default value for that shape.

Defining Your Own Menu Colors

The SmartDraw color menu shows a choice for **More Colors**. If you choose this, you see the **Color Dialog**. This lets you pick from any of the 16 million colors Windows offers.

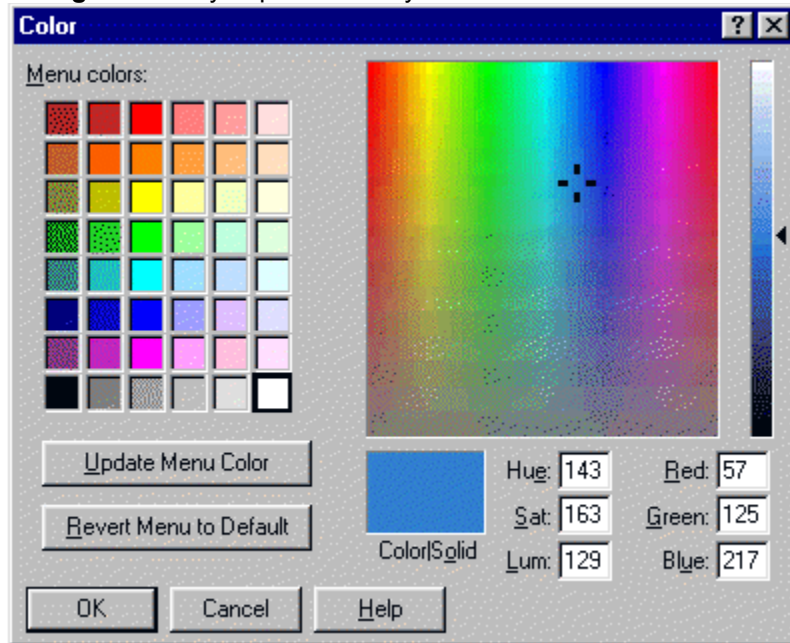

The Color Dialog

To define a custom color, first move the slider control up and down to achieve the amount of black and white you want in the color. Next, click in the color window to choose the hue of the color you want. Your choice shows in the **Color/Solid** box.

You can also enter an explicit RGB or HSL value for the color in the fields that show these values.

Once you have chosen the color you want, press OK to apply it to your drawing.

You can also use this dialog to customize the SmartDraw color menu. Once you have chosen the color using the color controls, pressing the **Update Color Menu** button will update the currently selected *square* on the color menu with the color in the color box. This new color will show in this square in all the color menus from now on. You can click on any square in the color menu before you press the Update button, to select the square whose color you want to replace.

Double clicking on a menu square copies its color to the color box.

Pressing the **Revert Menu to Default** button changes all the menus back to their default settings.

SmartDraw Software Inc. provides technical support under the following terms and conditions:

Technical Support

Up to 30 minutes of support is provided at no charge for the first 90 days following purchase. Please have your invoice number ready. This is shown clearly on your purchase invoice, returned to you as acknowledgement of your purchase.

After 90 days you may call with a credit card and obtain support at the rate of \$7.50 per 5 minutes. There is no charge for hold time, and no charge if the problem is identified as a "bug" in SmartDraw. Whether the problem qualifies as a bug is at the sole discretion of SmartDraw Software Inc.

If a user reports a bug that prevents proper use of the program during the first 90 days following registration, SmartDraw Software will either fix the bug, or offer a complete refund.

Suggestions

We invite suggestions. There is never any charge for suggestions. Please contact us.

Using the Web

Please visit our Web site at:

<http://www.smartdraw.com>

Here you will find news of the latest releases, patches, tips and useful information. If your web browser is installed in the right (Microsoft) way, you can connect to our web site by simply selecting the **Browse SmartDraw Web Page** command, under the Help menu.

Downloading the Latest Version

We frequently offer free updates that include bug fixes and new features. To download these simply use the **Get Latest Version** command, under the Help menu. or visit

<http://www.smartdraw.com/techsup.htm>

Getting Support

The best way to do this is via electronic mail. There is currently no charge for email support. Our email address is:

support@smartdraw.com

You can also call us at **(619) 549 0314**.

When reporting a problem, please include the following information:

- 1) Your system configuration (version of Windows, printer, display type etc.)
- 2) A description of **how to reproduce** the problem.
- 3) A sample file that exhibits the problem (if possible).

Troubleshooting

To get instant information about the most common user problems, use the **Get Latest Version** command, under the Help menu, to connect to our technical support web pages or visit

<http://www.smartdraw.com/techsup.htm>

Below we address some of the more common problems:

Windows Errors or Crashes

If SmartDraw crashes (stops working) when you attempt to create a new drawing, or open an existing one, the most common cause is the printer setting.

When SmartDraw does either of these things it loads the current printer's driver to determine the size of the printable area of the current page setting.

If your printer's block of default parameters is corrupted or the driver is not correctly installed, this can cause the system to crash.

To test whether this is the cause of your problem, go to the Windows control panel and change the default printer setting to some other printer. Now try SmartDraw again. If the problem goes away you know that the original default printer's driver causes it.

To correct the problem, try re-installing the driver using the Windows printer control panel.

If this does not appear to be the problem, please contact us at support@smartdraw.com and email us a copy of the file that causes the SmartDraw to crash upon opening.

Drawing Problems. The Graphics Acceleration Setting.

Some graphics controller boards use some hardware optimizations in attempt to speed up common graphics operations. Leaving these features turned on can cause graphic-intensive applications like SmartDraw to fail.

Two common symptoms of this problem are small dots that are left behind on the screen when you move and object, and the wrong colors appearing inside shapes when you paste an image into another program.

To correct these and similar problems, turn these optimizations off.

To do this go to the **Windows Control Panel** and open the **System** icon. Go to the **Performance** tab and press the **Graphics** button. Move the slider control all the way to the left, to turn off graphics acceleration. Now press OK and restart your application.

Trial Version Runs Instead of Purchased Version

If, after you have installed your purchased SmartDraw program, it still says **Trial Version**, when you run it then you are in fact still running your old Trial Version (which is still on your computer) instead of the new purchased version that you installed.

You probably have a "shortcut" to the Trial Version, either on your desktop or in your Start Menu. You need to stop using this shortcut (you can also delete it if you like). Instead use the new shortcuts (on your desktop and start menu) that the purchased version of SmartDraw created during its installation. If SmartDraw failed to create these new shortcuts for some reason, you can create your own.

First start Windows Explorer and locate the file named **smartdraw.exe** in the directory where you installed SmartDraw on your hard disk. Right-click on the file with your mouse, and choose "create shortcut" from the menu. A shortcut will be created in that directory. Simply drag the shortcut onto your desktop, and it will become an icon that you can click on to run SmartDraw.

Colors Do Not Print

If your drawing has colored shapes and lines but they do not print in color (even though you have a color printer) make sure that the **Print No Color** box in the Print dialog is **unchecked**. If this is not the problem, check the **Properties** in the print dialog to make sure that your printer is set up to print color.

How Do I?

Print on landscape paper?

SmartDraw drawings can be printed in either the portrait or landscape direction on the paper. To change this setting use the Page Setup dialog under **the File Menu**.

Print my big drawing on one page?

To print a drawing so that it fits on one page, check the Print on One Page check box in the Print dialog. If this box is checked, SmartDraw will scale your drawing to fit on the page. If your drawing is really large this may cause text to be less readable.

Transfer a drawing to another program?

The simplest way to insert a SmartDraw drawing into another program, like a word processor, is to copy and paste. Make sure no objects are selected, then use the **Copy** command (**Edit Menu**). This places a copy of the drawing on the clipboard. Then go to the word processor (or any other program) and use the Paste command. The drawing will be inserted into the word processor's document.

You can also save a SmartDraw drawing in a number of different file formats.

Save a drawing in another file format?

Use the Export command under the **File Menu** to save a SmartDraw drawing in another file format. With SmartDraw Standard, formats supported include GIF, BMP, JPEG, and WMF. The WMF format (Windows Metafile) is the best choice if you want to later import the drawing into another program because it is a "vector" format that scales properly.

With SmartDraw Professional, you can also import and export in EPS (Postscript format), AutoCAD, PDF, and many other formats.

Transfer a drawing to a web page?

Use the Export command under the **File Menu** to save the drawing in either a GIF or JPEG format. This will create a web compatible bitmap of your drawing. Insert this GIF or JPEG image into your HTML page using a web-page editor. When you save to GIF, SmartDraw gives you the option of creating an image with a background that will appear to be transparent on your web page.

Move things very precisely?

When one or more objects are selected, pressing the **Arrow Keys** on the keyboard moves the objects by one pixel at a time in the direction of the arrow. The Snap-to grid is ignored for this operation.

You can also use the Position and Size command under the Arrange menu to move an object to an exact coordinate that you enter with the keyboard.

Connect shapes with perfectly straight lines

With SmartDraw, you can connect two shapes with a line that stays connected when the shape at either end is moved. This is described in detail elsewhere. Sometimes the line connecting the shapes is not perfectly straight because of the positions of the connect points on each shape.

The **best way to avoid this problem** is to set the Snap to Grid feature so that the **center of shapes** snap to the grid. If the lines used to link the shapes are attached at the center of the sides of the shapes, the connecting lines will be perfectly straight. Note that the snap to grid in drawings created with versions 1.0 and 2.0 is **NOT** set this way. Go to the **Define Rulers and Grid** command under the Edit menu to

correct this.

Another way to correct this problem is by adjusting the shape positions with the arrow keys. If you select a line or shape by clicking on it, you can adjust its position by 1 screen pixel up, down, left or right by typing the arrow keys on the keyboard. Use this feature to fine tune the position of objects without regard to the Snap-to Grid.

Keep the toolbar buttons selected

Normally when you click on a tool in the toolbar (or a library window) and you draw a line or shape, the pointer tool (the arrow) become selected immediately afterwards. You can keep a tool selected, so that you can draw multiple lines or shapes pressing its button each time, by holding the **Shift** key down when you first select the tool by clicking on it.

Move a collection of objects as a group

You can move some, or all, of the objects in your drawing without disturbing their relative positions by first selecting them and then by moving just one of the objects. The rest of the selection will also move.

You can select more than one object at a time very easily, on several different ways You can move a collection of objects in the same ways as a single object. Using the mouse, the arrow keys and the Align command.

You can also use the Group command to formally combine selected objects into a single object.

SmartDraw Software License Agreement (Purchased Copy)

Grant of License

This SmartDraw license agreement grants you a non-exclusive right to load and use the SmartDraw Software (the "Software").

The software is "loaded" onto a computer when it is either copied to the permanent memory of the computer (the hard disk) or loaded into the temporary memory (RAM), such as when a computer runs the software from a network server, or a floppy disk.

Single vs. Multiple Use

You may use the software only on a single computer, or on up to two computers used exclusively by the same individual user, unless otherwise specified in a receipt for a multiple-use license.

If a multiple-use license is purchased, the software may only be used on more than one computer, at the same site, or connected to the same network, provided that the number of computers that have either direct or networked access to the software do not exceed the number specified in the receipt for the multiple use license. For example, if a license for use on 100 computers is purchased, the software cannot be installed such that more than 100 computers may load it.

Copyright

The Software is owned by SmartDraw Software Inc. and is protected by United States copyright laws and international treaty provisions. You must treat the software like any other copyrighted material (for example, a book), except that you may make a copy for the purposes of loading it onto the hard disk of the computers that are licensed under this agreement.

Other Restrictions

You may not transfer your rights under this agreement. You must not rent or lease this software. You may not decompile or disassemble the Software. You may not distribute the Software as part of any of any other software, or collection of software without the written agreement of SmartDraw Software Inc.

LIMITED WARRANTY AND DISCLAIMER OF WARRANTY

THIS SOFTWARE AND ACCOMPANYING WRITTEN MATERIALS (INCLUDING INSTRUCTIONS FOR USE) ARE PROVIDED "AS IS" WITHOUT WARRANTY OF ANY KIND. FURTHER, SMARTDRAW SOFTWARE INC. DOES NOT WARRANT, GUARANTEE, OR MAKE ANY REPRESENTATIONS REGARDING THE USE, OR THE RESULTS OF USE, OF THE SOFTWARE OR WRITTEN MATERIALS IN TERMS OF CORRECTNESS, ACCURACY, RELIABILITY, CURRENTNESS, OR OTHERWISE. THE ENTIRE RISK AS TO THE RESULTS AND PERFORMANCE OF THE SOFTWARE IS ASSUMED BY YOU. IF THE SOFTWARE OR WRITTEN MATERIALS ARE DEFECTIVE YOU, AND NOT SMARTDRAW SOFTWARE INC. OR ITS DEALERS, DISTRIBUTORS, AGENTS, OR EMPLOYEES, ASSUME THE ENTIRE COST OF ALL NECESSARY SERVICING, REPAIR, OR CORRECTION.

THE ABOVE IS THE ONLY WARRANTY OF ANY KIND, EITHER EXPRESS OR IMPLIED, INCLUDING BUT NOT LIMITED TO THE IMPLIED WARRANTIES OF MERCHANTABILITY AND FITNESS FOR A PARTICULAR PURPOSE, THAT IS MADE BY SMARTDRAW SOFTWARE INC., ON THIS SMARTDRAW SOFTWARE INC. PRODUCT. NO ORAL OR WRITTEN INFORMATION OR ADVICE GIVEN BY SMARTDRAW SOFTWARE INC., ITS DEALERS, DISTRIBUTORS, AGENTS OR EMPLOYEES SHALL CREATE A WARRANTY OR IN ANY WAY INCREASE THE SCOPE OF THIS WARRANTY AND YOU MAY NOT RELY ON ANY SUCH INFORMATION OR ADVICE. YOU MAY HAVE OTHER RIGHTS WHICH VARY FROM STATE TO STATE.

NEITHER SMARTDRAW SOFTWARE INC. NOR ANYONE ELSE WHO HAS BEEN INVOLVED IN THE CREATION, PRODUCTION OR DELIVERY OF THIS PRODUCT SHALL BE LIABLE FOR ANY DIRECT, INDIRECT, CONSEQUENTIAL OR INCIDENTAL DAMAGES (INCLUDING DAMAGES FOR LOSS OF BUSINESS PROFITS, BUSINESS INTERRUPTION, LOSS OF BUSINESS INFORMATION, AND THE

LIKE) ARISING OUT OF THE USE OR INABILITY TO USE SUCH PRODUCT EVEN IF SMARTDRAW SOFTWARE INC. HAS BEEN ADVISED OF THE POSSIBILITY OF SUCH DAMAGES.

SmartDraw Software License Agreement (Trial Edition)

Grant of License

This SmartDraw license agreement grants you a non-exclusive right to load and use the SmartDraw Software Trial Version 3 (the "Software") for a period of 30 days from the date that the software was first loaded on one or more computers. Once the 30 day period has expired, you (the licensee) agree to either purchase a permanent license to use the software, or to destroy the Software and all copies in your possession.

The software is "loaded" onto a computer when it is either copied to the permanent memory of the computer (the hard disk) or loaded into the temporary memory (RAM), such as when a computer runs the software from a network server, or a floppy disk.

Single vs. Multiple Use

You may use the software only on a single computer, or on up to two computers used exclusively by the same individual user, unless otherwise specified in a receipt for a multiple-use license.

If a multiple-use license is purchased, the software may only be used on more than one computer, at the same site, or connected to the same network, provided that the number of computers that have either direct or networked access to the software do not exceed the number specified in the receipt for the multiple use license. For example, if a license for use on 100 computers is purchased, the software cannot be installed such that more than 100 computers may load it.

Copyright

The Software is owned by SmartDraw Software Inc. and is protected by United States copyright laws and international treaty provisions. You must treat the software like any other copyrighted material (for example, a book), except that you may make a copy for the purposes of loading it onto the hard disk of the computers that are licensed under this agreement.

Other Restrictions

You may not transfer your rights under this agreement. You must not rent or lease this software. You may not decompile or disassemble the Software. You may not distribute the Software as part of any of any other software, or collection of software without the written agreement of SmartDraw Software Inc.

LIMITED WARRANTY AND DISCLAIMER OF WARRANTY

THIS SOFTWARE AND ACCOMPANYING WRITTEN MATERIALS (INCLUDING INSTRUCTIONS FOR USE) ARE PROVIDED "AS IS" WITHOUT WARRANTY OF ANY KIND. FURTHER, SMARTDRAW SOFTWARE INC. DOES NOT WARRANT, GUARANTEE, OR MAKE ANY REPRESENTATIONS REGARDING THE USE, OR THE RESULTS OF USE, OF THE SOFTWARE OR WRITTEN MATERIALS IN TERMS OF CORRECTNESS, ACCURACY, RELIABILITY, CURRENTNESS, OR OTHERWISE. THE ENTIRE RISK AS TO THE RESULTS AND PERFORMANCE OF THE SOFTWARE IS ASSUMED BY YOU. IF THE SOFTWARE OR WRITTEN MATERIALS ARE DEFECTIVE YOU, AND NOT SMARTDRAW SOFTWARE INC. OR ITS DEALERS, DISTRIBUTORS, AGENTS, OR EMPLOYEES, ASSUME THE ENTIRE COST OF ALL NECESSARY SERVICING, REPAIR, OR CORRECTION.

THE ABOVE IS THE ONLY WARRANTY OF ANY KIND, EITHER EXPRESS OR IMPLIED, INCLUDING BUT NOT LIMITED TO THE IMPLIED WARRANTIES OF MERCHANTABILITY AND FITNESS FOR A PARTICULAR PURPOSE, THAT IS MADE BY SMARTDRAW SOFTWARE INC., ON THIS SMARTDRAW SOFTWARE INC. PRODUCT. NO ORAL OR WRITTEN INFORMATION OR ADVICE GIVEN BY SMARTDRAW SOFTWARE INC., ITS DEALERS, DISTRIBUTORS, AGENTS OR EMPLOYEES SHALL CREATE A WARRANTY OR IN ANY WAY INCREASE THE SCOPE OF THIS WARRANTY AND YOU MAY NOT RELY ON ANY SUCH INFORMATION OR ADVICE. YOU MAY HAVE OTHER RIGHTS WHICH VARY FROM STATE TO STATE.

NEITHER SMARTDRAW SOFTWARE INC. NOR ANYONE ELSE WHO HAS BEEN INVOLVED IN THE

CREATION, PRODUCTION OR DELIVERY OF THIS PRODUCT SHALL BE LIABLE FOR ANY DIRECT, INDIRECT, CONSEQUENTIAL OR INCIDENTAL DAMAGES (INCLUDING DAMAGES FOR LOSS OF BUSINESS PROFITS, BUSINESS INTERRUPTION, LOSS OF BUSINESS INFORMATION, AND THE LIKE) ARISING OUT OF THE USE OR INABILITY TO USE SUCH PRODUCT EVEN IF SMARTDRAW SOFTWARE INC. HAS BEEN ADVISED OF THE POSSIBILITY OF SUCH DAMAGES.

Some Objects do not Rotate

The following objects do not support rotation: Connectors, Segmented Lines and Curves, Image Objects that contain bitmaps. Any group that contains these kind of objects also does not rotate.

Some Metafiles are not Supported

SmartDraw will not import or paste certain metafiles that contain rarely used obsolete instructions. If you encounter this message, please contact us at support@smartdraw.com and send us a copy of the metafile that will not import.

Send

SmartDraw supports the standard Windows Send command. This is found on the File menu. This sends your current document, or all open documents, to an email address embedded in an email message.

Connecting to the Web

The **Browse SmartDraw Web Page** and the **Get The Latest Version of SmartDraw** commands connect your web browser to our web site. These commands may not work if your browser does not follow the Windows standard for registration.

Large SmartDrawings are not a good idea

The Windows Metafile that you are attempting to add to the symbol library exceeds 1,000,000 bytes. Metafiles of this size do not make good symbols.

Metafiles that are this large are usually very complex line drawings, or bitmaps. Symbols are better when they are small and simple line drawings. Very complex drawings are slow and cumbersome. Symbols that are derived from scanned or bitmapped images do not scale or print well at high resolution.

This option is only available if the raised or sunken 3D shadow styles are chosen. Checking this box applies the reverse text shadow: Raised if the shape shadow is sunken, sunken if the shape shadow is raised. This can give an interesting effect.

Checking this box applies the shadow style selected to text as well as to shapes. This is only visible if a shadow style is selected.
Text does not look good shadowed unless it has a point size of 18 or greater

Checking this box applies the shadow style selected to lines as well as to shapes. This is only visible if a shadow style is selected, and is forced to be on for the raised and sunken shadow styles.

The four push buttons show the current angle for the shadow. Pressing one changes the selection to the angle shown on its face. These controls are only visible if one of the shadow styles in the right column of the shadow control is selected.

The six push buttons show the range of shadow styles available with the top left button representing no shadow. If a shadow style in the right column is selected, the angle of the shadow can also be controlled using the controls labeled Angle. Shadows can be applied optionally to lines and text. Check boxes control these selections.

Seven color panels are displayed showing the current color scheme. Pressing on any color panel with the mouse displays the color menu. Use the menu to change the color selection.

The **highlight** color is only used by the raised and sunken three dimensional shadow styles.

This button is active when the name in the **Name** field matches the style selected in the list. Pressing it removes the selected style from the list.

This button is active when the name in the **Name** field matches the style selected in the list. Pressing it changes the selected style to the current color and shadow settings.

This button is active when the name in the **Name** field does not match the style selected in the list, and the settings for colors and shadow have been changed. Pressing it adds the current color and shadow settings as a new style.

The text in the name field is the current name of the style being edited. If this matches the name of the style that is shown selected in the list, the **Change** button is active, and the current style is changed if it is pressed. If the name does not match the selected name in the list, the **Add** button is active and pressing it adds a new style to the list. If there is nothing typed in the field, both buttons are inactive.

This area shows a preview of the current style as the selection in the list is changed, and as the settings for the selected style are changed.

This button becomes active when the name of the selected style has been changed, but the parameters have not. Pressing it renames the current style.

Selecting an item in this list selects the style for editing. The style's name is copied into the **Name** field, and the **Change** button becomes active. Any changes to the previously selected item's style are canceled.

Shows the list of styles to choose from.

Press this button to add new styles, or change the settings for existing styles.

Checking this box applies changes to the fill colors and text colors of shapes.

Checking this box applies changes to the colors of borders and lines.

This field is only visible if the shape selected for the button may be adjusted in some way. The parameter value represents a proportion of the width or height of the shape and is usually limited to a range of 0.1 to 0.4, or sometimes less. The effect of the change can be seen in the preview window if you click on it or click in another field.

Changing the shape assigned to the button will change the adjustment to its default value for that shape.

A button shows the shape currently selected for this toolbar location. Pressing the button presents a menu of standard shapes. Selecting one changes the assignment of the button to the selected shape.

The width and height fields control the size of the shape associated with this button when one is created using a drag and drop operation. For circles, and other shapes that can only be sized proportionately, changing one value changes the other, so as to maintain the same proportions.

This collection of buttons controls the type and displacement of the arrowhead that will appear on the left end (or top end for vertical lines) of the selected lines. Note the center position arrows.

This collection of buttons controls the type and displacement of the arrowhead that will appear on the right end (or bottom end for vertical lines) of the selected lines. Note the center position arrows.

If you double click on this button you can define your own custom arrowhead shape.

These buttons control the size of the arrows, and applies to both ends of the line.

Shows a preview of a horizontal line linked at each end to a shape with the arrowhead properties that reflect the current settings in the dialog.

The two buttons shown for this property control whether the end of a line with an arrowhead is drawn its full length or a little short. This is useful when lines are linked to shapes. If the line is displaced it does not appear to touch the shape but still remains linked to it. This property can be controlled independently for each end of a line, and does not apply to ends with no arrowhead.

Pressing this button reverts all the arrow buttons to their original settings, and removes all custom arrow definitions.

For **Automatic** symbols, checking this box causes copies of this symbol added to a drawing to adopt the current document color scheme. Leaving it unchecked initially preserves its colors. The colors and other properties of Automatic Symbols can always be changed.

For **Non-Automatic** symbols, checking this box allows **SmartDraw** to change the color of the fills, lines, border and text that show in the symbol. The style and thickness of borders and lines can also be changed. These settings are controlled by the **Shape** menu, not the **Line** or **Text** menu.

The color of the text, lines and borders follows the **Border Color** setting. The fills follow the **Fill Color**. Transparent fills are not affected by the Fill Color.

If this box is not checked, the drawing behaves like an Image Object. Applying a border style places a border around the symbol but does not change the contents.

The substitution of colors for lines, fills etc. may not work for all symbols. If the image contains bitmapped images these may be unaffected by checking the color box. If you check this box you should experiment with a copy of the symbol to see the effects of color changes. If these are not satisfactory, return to the dialog and uncheck the box again.

The Image window shows the symbol image against a grid of green lines. A dotted border shows the edges of the drawing rectangle. If **Automatic** is **NOT** checked:

Each drawing has 16 **Connection Points** shown as solid black circles. These are the points at which lines and other shapes will link to this drawing. Clicking on the circles and dragging with the mouse button held down allows you to move them. The connect points should be arranged on the borders of the drawing. To be active, connect points must lie outside the margin lines (whether text is entered **Inside the Drawing** or not).

You can finely adjust the position of connect points using the F5, F6, F7 and F8 keys. The point most recently clicked-on, moves left, right, up and down respectively by 1 pixel, when these keys are typed.

When the text setting is **Inside the Drawing**, four margin lines appear. These can be moved by clicking on the square handles at each end and dragging. By default these are set to create the smallest text entry area possible between all four lines. This should be expanded to allow the largest area that still forces all text to lie within the borders of the shape. When text is entered **Above** or **Below** the drawing, the margin lines are ignored.

Symbols can display text. This text can be **Inside the drawing** like the standard 24 shapes, or **Above** or **Below** it. The fourth choice, **No text**, means that the drawing will not respond to the normal text entry commands.

If **Inside the Drawing** is selected, four margin lines appear inside the **Image** window. These should be adjusted so that the text area within the four lines does not overlap the boundaries of the symbol.

This setting is **grayed out for Automatic** symbols.

These four radio buttons control the way in which the Symbol can be re-sized.

Proportional drawings have only four grow handles (one at each corner) and maintain their proportions when re-sized.

Horizontal Only drawings have only two grow handles and can be re-sized only in the horizontal direction. This is good for drawings that represent horizontal lines.

Vertical Only drawings have only two grow handles and can be re-sized only in the vertical direction. This is good for drawings that represent vertical lines.

No restrictions allows drawings to grow in all directions without maintaining proportions. These drawings have the usual 8 grow handles.

This setting is **grayed out for Automatic** symbols.

You can enter an optional name for the symbol in this field. The **Names** command under the **Libraries** menu changes the buttons in the symbol window to show the names you assign to each symbol instead of their picture.

Any words typed after a semi colon(;) are not displayed in Tooltips or in the button, but are used by the "search by name" feature.

The width and height fields control the size of the Symbol when it is created using **Drag and Drop**. If the **Grow** setting is set to **Proportional**, changing one value changes the other, so as to maintain the same proportions. This setting is **grayed out for Automatic** symbols.

This checkbox controls whether a symbol retains its SmartDraw native format and uses the automatic settings associated with its objects (**Automatic** format), or displays a Windows Metafile image and uses the settings applied using this dialog (**Metafile** format).

Symbols created in SmartDraw itself can have either format. Symbols created outside SmartDraw cannot have automatic settings and so for these symbols the Automatic checkbox is unchecked and disabled.

The **Type** control shows the available templates by **drawing type**. The named types are the names of file system directories, or folders, within the **Templates** folder, where the templates in this type are stored. The Empty Flowchart type is always present and allows you to create a new empty Flowchart type.

Shows a thumbnail of the template currently selected in the **Name** list. This makes it easy to browse through the available templates, until you find the one that right for your task.

Once you have selected the template that you want, pressing the **OK** button creates a new drawing that is a copy of the template. Changes made to this copy do not affect the original.

Shows a list of templates by name that belong to the drawing-type shown above.

SmartDraw will display hints for beginning users if this box is checked. These are dialogs that pop-up automatically when you try to use certain features of the program for the first time. They attempt to explain what you are about to do and provide a direct route to more detailed help.

Each hint will only appear once in each **SmartDraw** session. **Hints** can be switched off from any **Hint** dialog. We recommend that you leave the **Hints** switched on the first few times that you use the program.

When a new drawing is created using the **New** command, or automatically when the program starts up, **SmartDraw** can create one in one of three ways.

- It can create a new empty drawing with the normal defaults.
- It can look for the file "SMRTDRAW.SDT" and attempt to open it as a new untitled drawing, or template. SMRTDRAW.SDT must be stored in the same DOS directory as the program.
- It can present the **New Drawing Dialog** allowing you to pick a template for the new drawing.

Make your choice by selecting the appropriate radio button.

SmartDraw first starts up it can either show the **Welcome Dialog**, automatically create a new drawing, or show the **Open Dialog**. Make your choice by clicking on the appropriate radio button.

At magnifications of 50% or below, the boundaries of the currently chosen page size are shown as dotted lines. Selecting the **All Magnifications** radio button causes these lines to be displayed in all magnifications.

For large drawings that have lots of complex symbols redrawing in the **Fit to Window** view can sometimes be time consuming. In these cases, you can increase redraw speed by choosing to draw only a rectangular frame instead of the whole image in this view, either always, or only when the symbol is small.

Checking this box causes an attached drawing to open in the maximized state, rather than as an overlapped window.

SmartDraw's libraries are organized into a dozen or more categories. These are shown in the drop-down **Category List**. Each category contains a group of libraries whose names are shown in the scrolling list control.

The scrolling list shows the names of all of the libraries in the currently selected category. As each one of the names in the list is selected, a preview of the symbols the library contains is displayed on the right. This makes it easy to browse through all the libraries looking for a particular symbol.

This shows a preview of the symbols contained in the selected library. Tooltips show the symbol name if you rest the mouse over one of the buttons.

Displays the **Find Symbol Dialog**, offering a means of searching for symbols by name.

Presents a standard file opening dialog allowing library files, outside of the LIBRARY folder in the program directory, to be opened.

Gives you immediate access to SmartDraw's web site in order to download more libraries.
Index

